

Physics 681: Solar Physics and Instrumentation – Lecture 7

Carsten Denker

NJIT Physics Department
Center for Solar–Terrestrial Research



High-Resolution Telescopes

- Image scale:
 $d = 2fr_{\odot} / A$
- Light-gathering power:
 $\sim (D/f)^2$ extended objects $\sim D^2$ point sources
- Effective focal length
- Long focus vs. short primary focus
- Optical aberrations
- Thermal control
- Scattered light
- Telescope mounts

September 22, 2005

Center for Solar-Terrestrial Research



Big Bear Solar Observatory



September 22, 2005

Center for Solar-Terrestrial Research



Domeless "Open" Telescopes



September 22, 2005

Center for Solar-Terrestrial Research



Heliostat

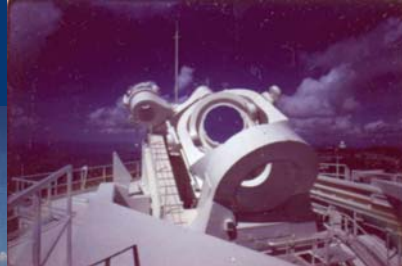

September 22, 2005

Center for Solar-Terrestrial Research



Coelostats

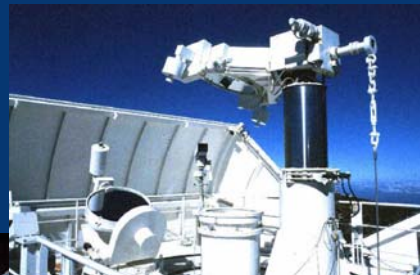

September 22, 2005

Center for Solar-Terrestrial Research



Tower Telescopes

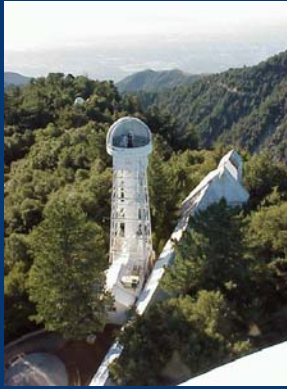

September 22, 2005

Center for Solar-Terrestrial Research



Turret Telescopes

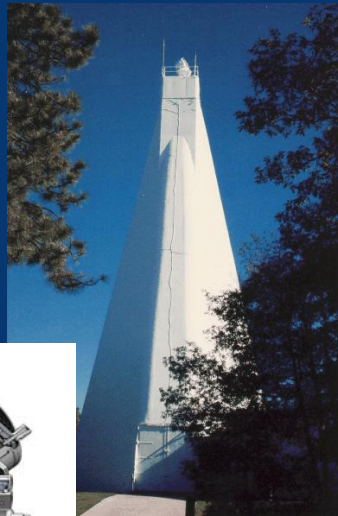
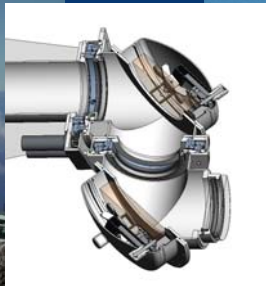

September 22, 2005

Center for Solar-Terrestrial Research



Variants

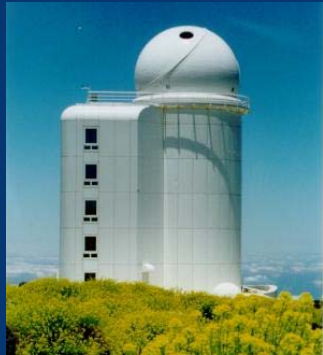

September 22, 2005

Center for Solar-Terrestrial Research



New Solar Telescope (NST)

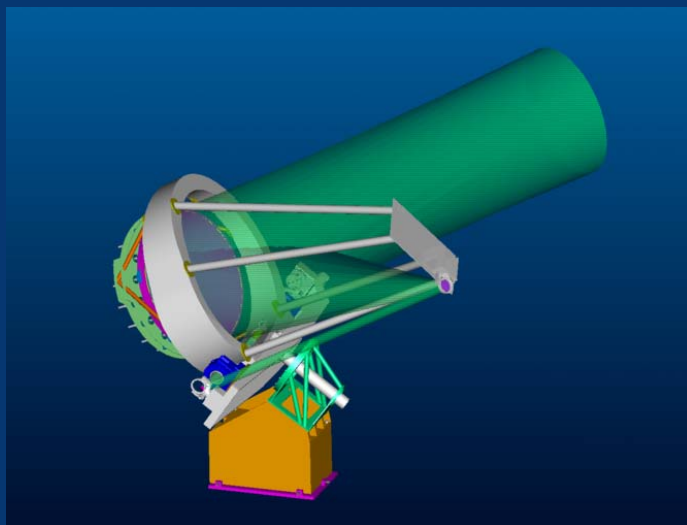

September 22, 2005

Center for Solar-Terrestrial Research



Advanced Technology Solar Telescope

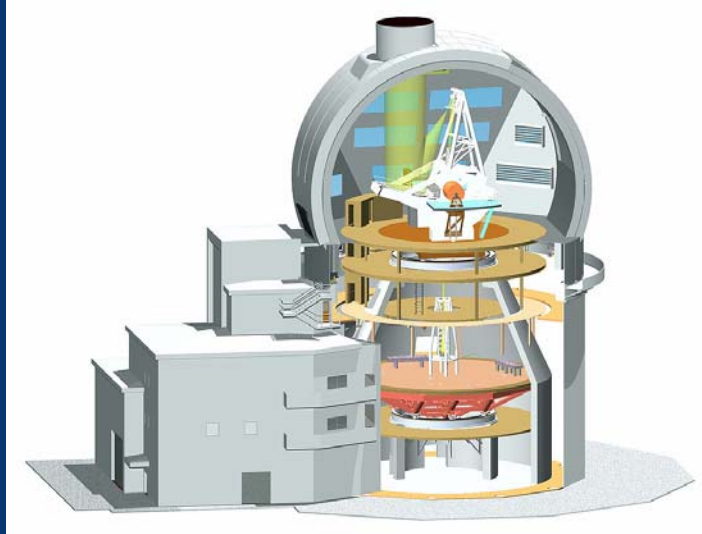

September 22, 2005

Center for Solar-Terrestrial Research



Optical Aberrations

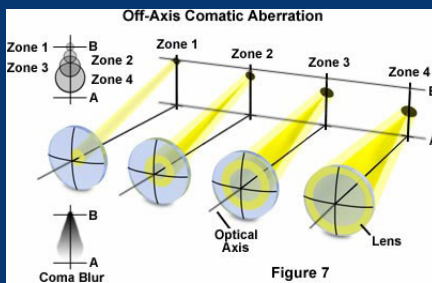
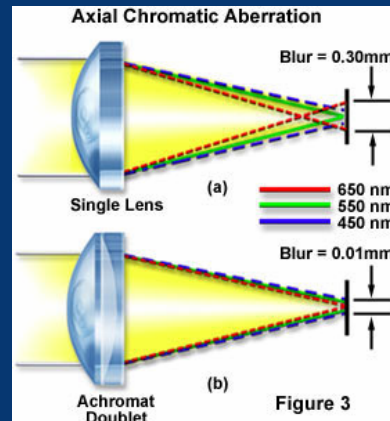
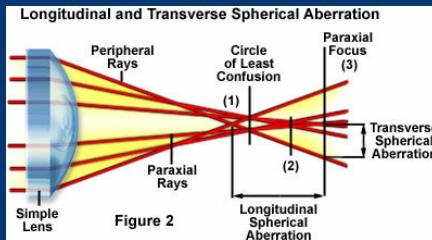

<http://micro.magnet.fsu.edu/primer/anatomy/aberrations.html>

September 22, 2005

Center for Solar-Terrestrial Research

