

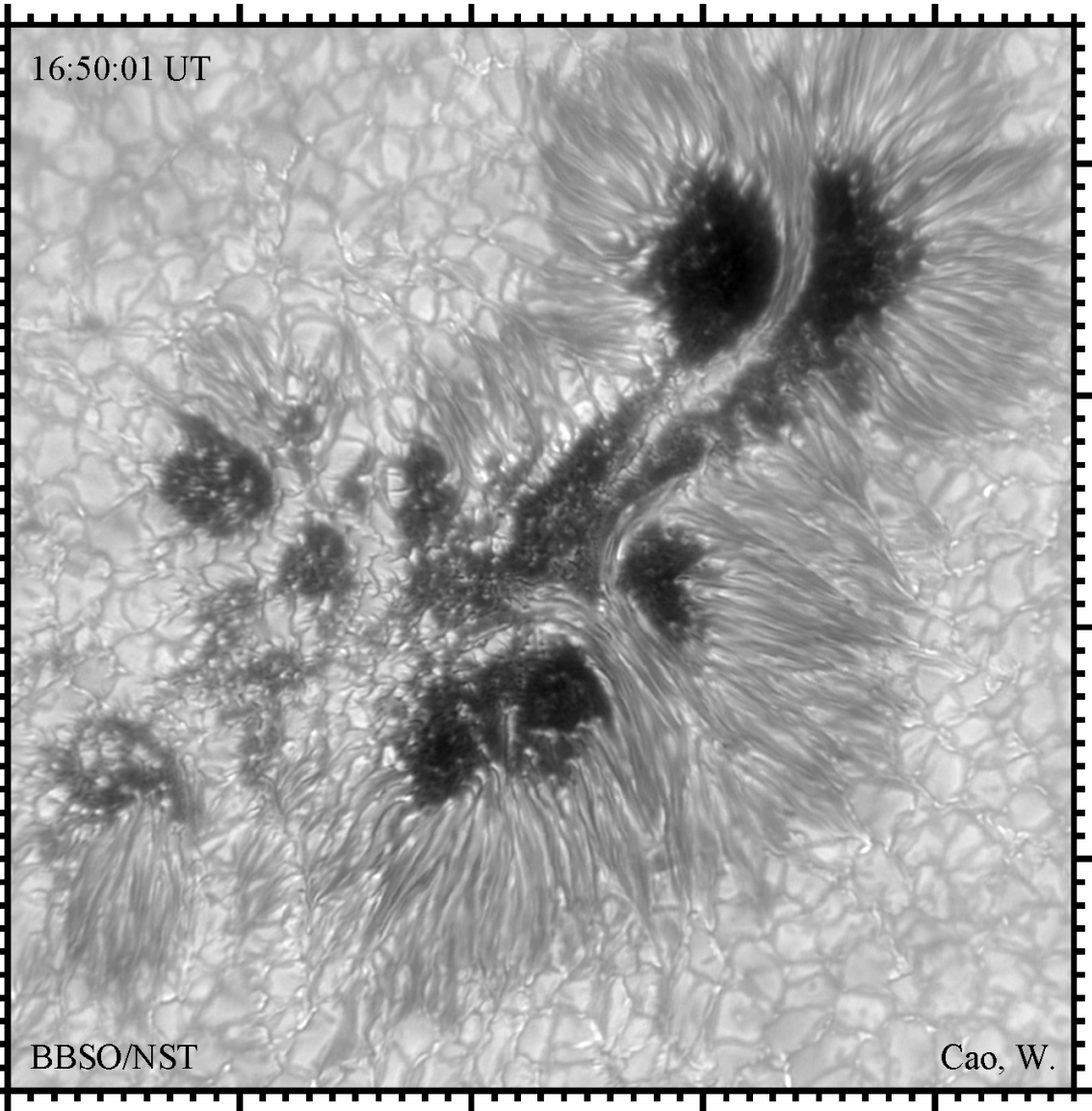

16:50:01 UT



BBSO/NST

Cao, W.

# Ground-based Solar Optical/IR Telescopes

*Wenda Cao*

*Big Bear Solar Observatory  
New Jersey Institute of Technology*

# Diffraction Limited Images

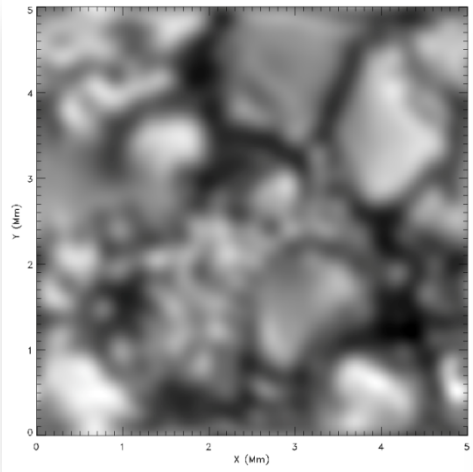

**D = 0.5 m**

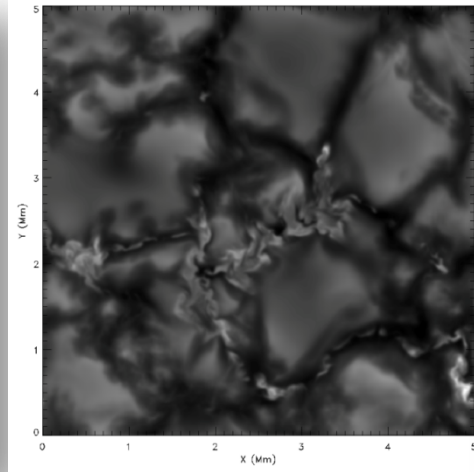

**D = 4.0 m**

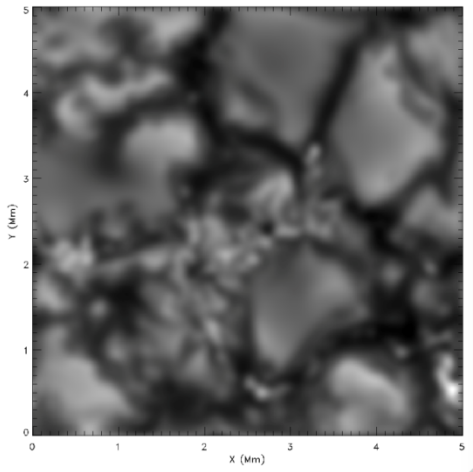

**D = 1.0 m**

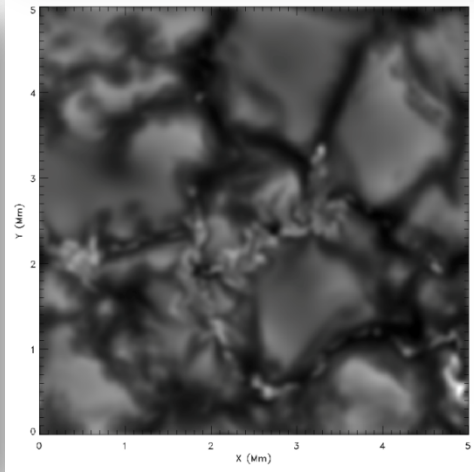

**D = 1.5 m**

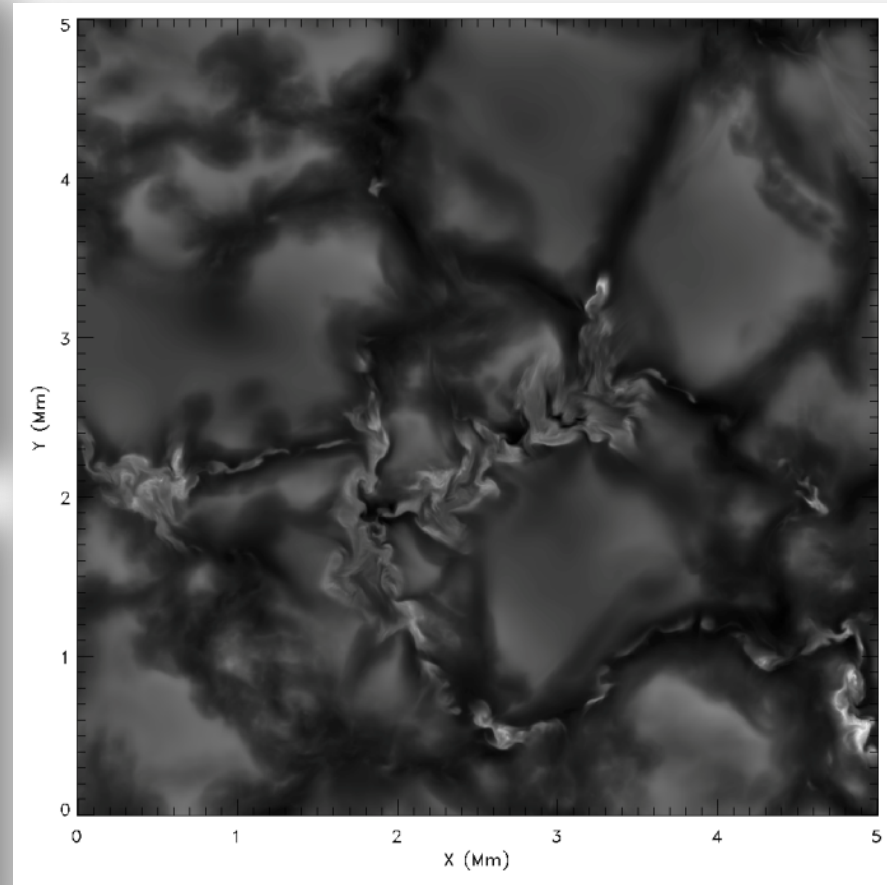

**Numerical 3D simulation – “real solar image”**

# Diffraction Limited Magnetograms

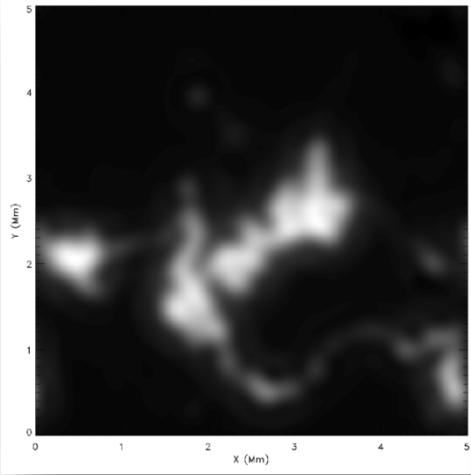

D = 0.5 m

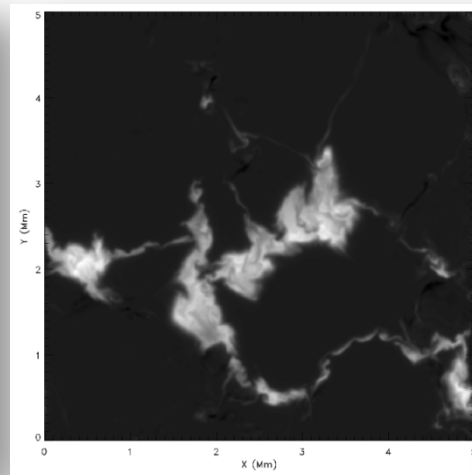

D = 4.0 m

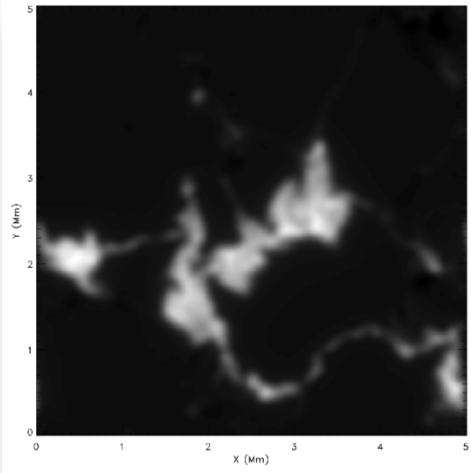

D = 1.0 m

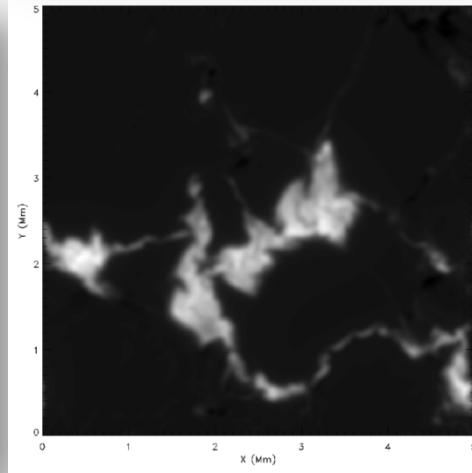

D = 1.5 m

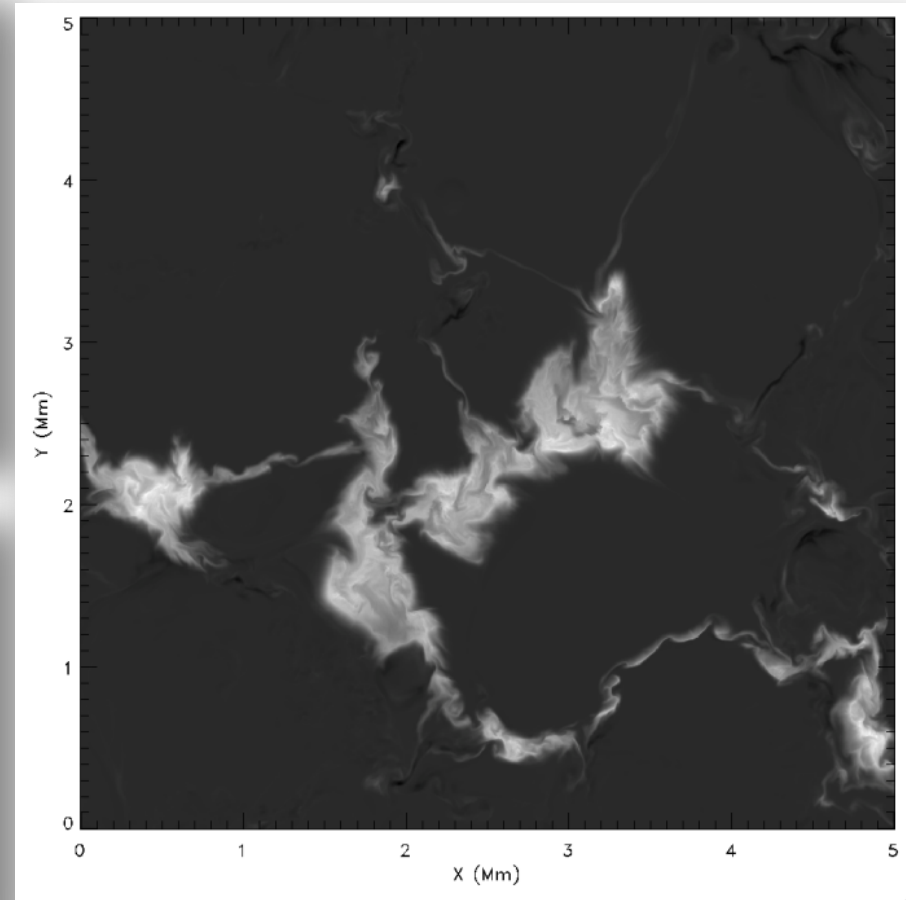

Simulation – “real solar magnetogram”

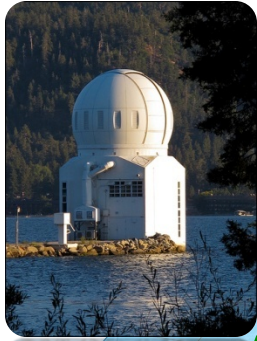

**1.6 m NST  
USA 2009**



**1 m SST  
Sweden 2002**

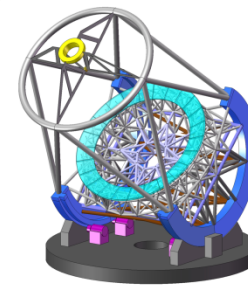

**8 m CGST  
China  
ASIA**



**1 m NVST  
China 2012**



**1 m FIRST  
China**

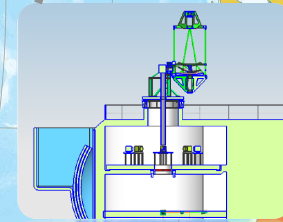

**2 m NLST  
India**



**1.5 m GREGOR  
Germany 2014**



**4 m EST  
EUR**

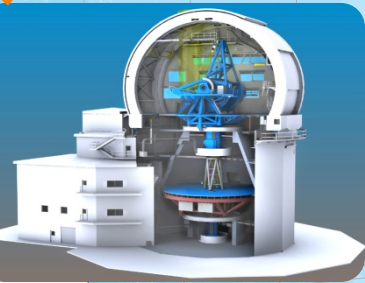

**4 m DKIST  
USA 2019**

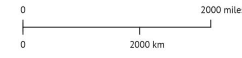
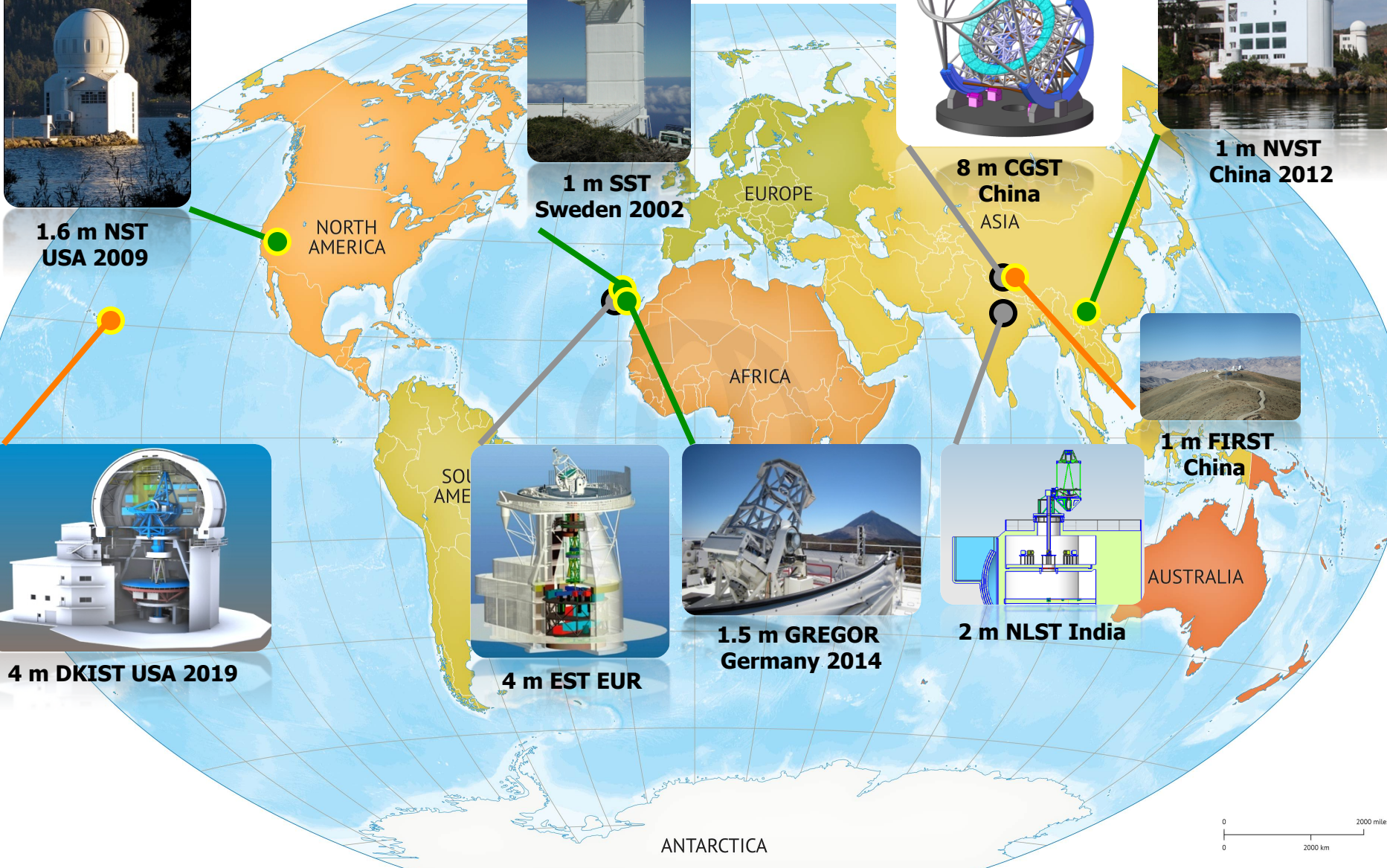

# US 4 meter DKIST



- ❖ **Danel K. Inouye Solar Telescope (DKIST, formerly the Advanced Technology Solar Telescope, ATST)**
- ❖ **Under construction phase atop Haleakala volcano on Maui, HI**
- ❖ **Project budget of \$ 0.26 Billion supported by US NSF**
- ❖ **Led by US NSO with a collaboration of 22 institutes**
- ❖ **Expect 1<sup>st</sup> light observation in 2019**



# DKIST Main Features

- Four-meter aperture
- All reflecting, Off axis optical design
- Integrated high-order adaptive optics (MCAO)
- Low-scattered light - coronal in NIR
- Integrated high-precision polarimetry
- Facility-class instruments

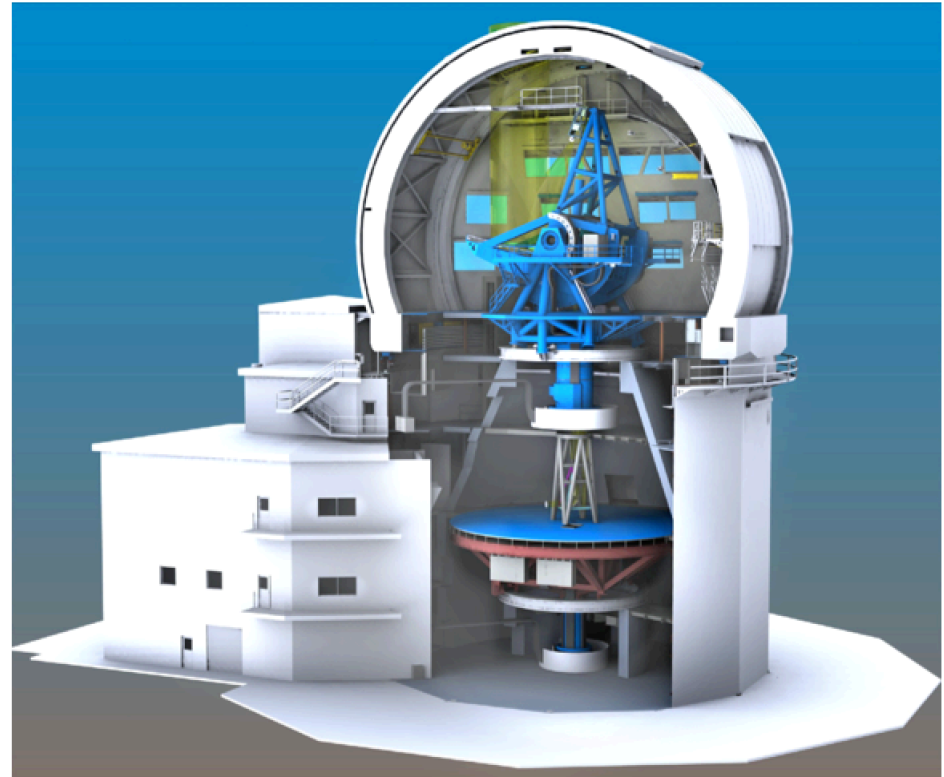

**High Spatial (25km@500nm), Spectral & Temporal Resolution**

**High Precision Polarimetry (accuracy  $5 \times 10^{-4}$ lc)**

**High Photon Flux, Low Scattered Light**

**Simultaneous UV, VIS, NIR & Far Infrared (new diagnostics)**

# First Light Instruments



- **VBI: Visible Broadband Imager (ATST)**
  - Red and blue channel
  - Diffraction limited imaging
- **ViSP: Visible Spectro-Polarimeter (HAO, Bc)**
  - versatile spectrograph & polarimeter
  - Broad selection of spectral lines
- **VTF: Visible Tunable Filter (KIS, Germany)**
  - 2D spectroscopy & polarimetry
- **DL-NIRSP: Diffraction Limited Near Infrared Spectro-polarimeter (IfA, Hawaii)**
  - 8 slit Spectrograph & polarimeter, near IR optimized
  - Covers photosphere to corona
- **Cryo-NIRSP: Cryogenic Near Infrared Spectro-polarimeter (IfA, Hawaii)**
  - Cryogenically cooled spectrograph & polarimeter
  - 1 to 5 micron
  - Coronal Magnetometry
  - Spatial resolution: 1 arcsec (photons, photons, photons)

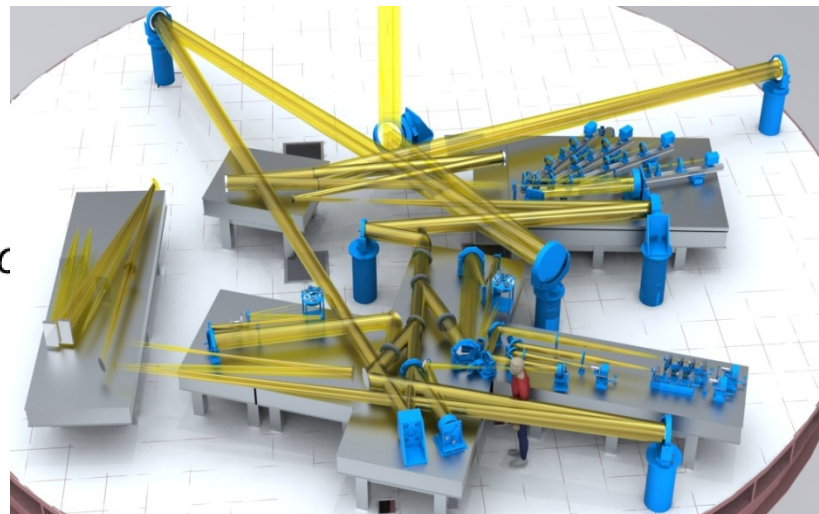

# DKIST Schedule Overview

## FY2010 Start

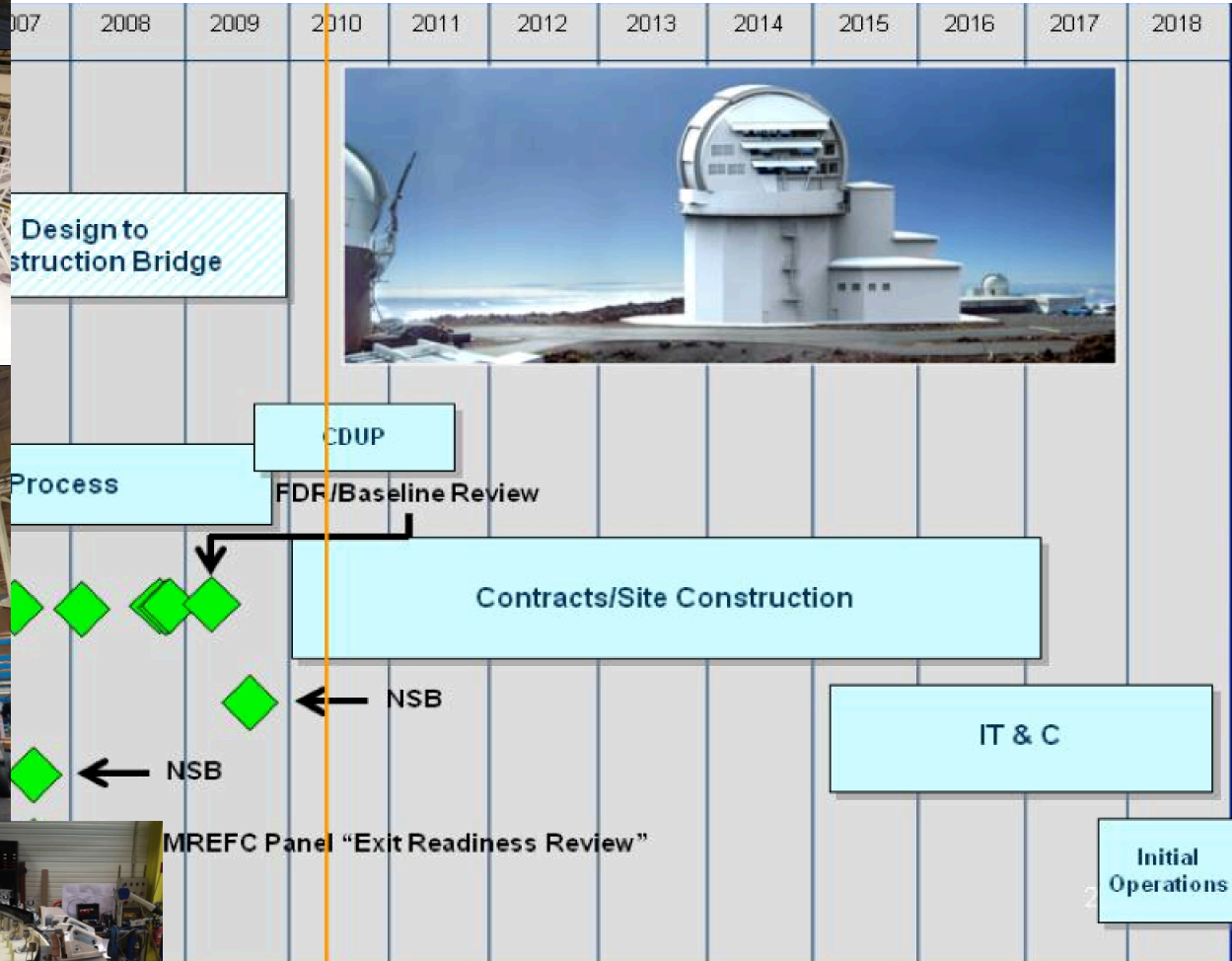

Courtesy : T. Rimmele



# US 1.6 meter NST

- ❖ NST is today in regular scientific use
- ❖ Big Bear Lake reduce ground level convection, and predominate winds bring smooth air flows across the flat surface of the lake
- ❖ Seeing character at Big Bear differs markedly from the high altitude, volcanic island sites measured in the ATST site survey. The median  $r_0$  for BBSO is shown in black (Hill et al. 2004)
- ❖ Observations using AO will be viable for extended periods during a typical day
- ❖ Median  $r_0 \sim 6$  cm, and wind speed  $\sim 4$ -8 m/s @ 500 nm

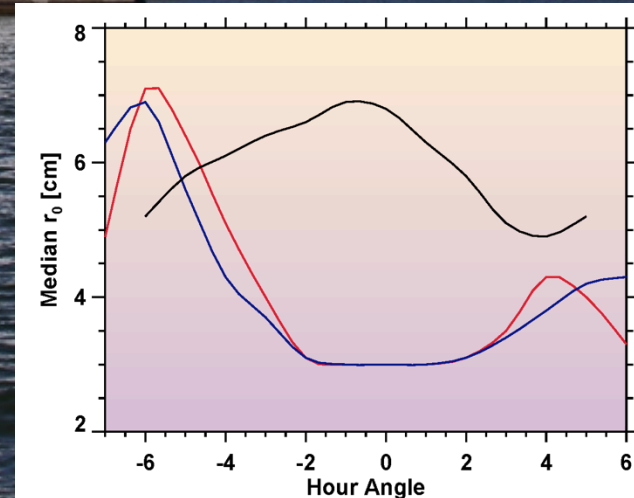



# NST Features

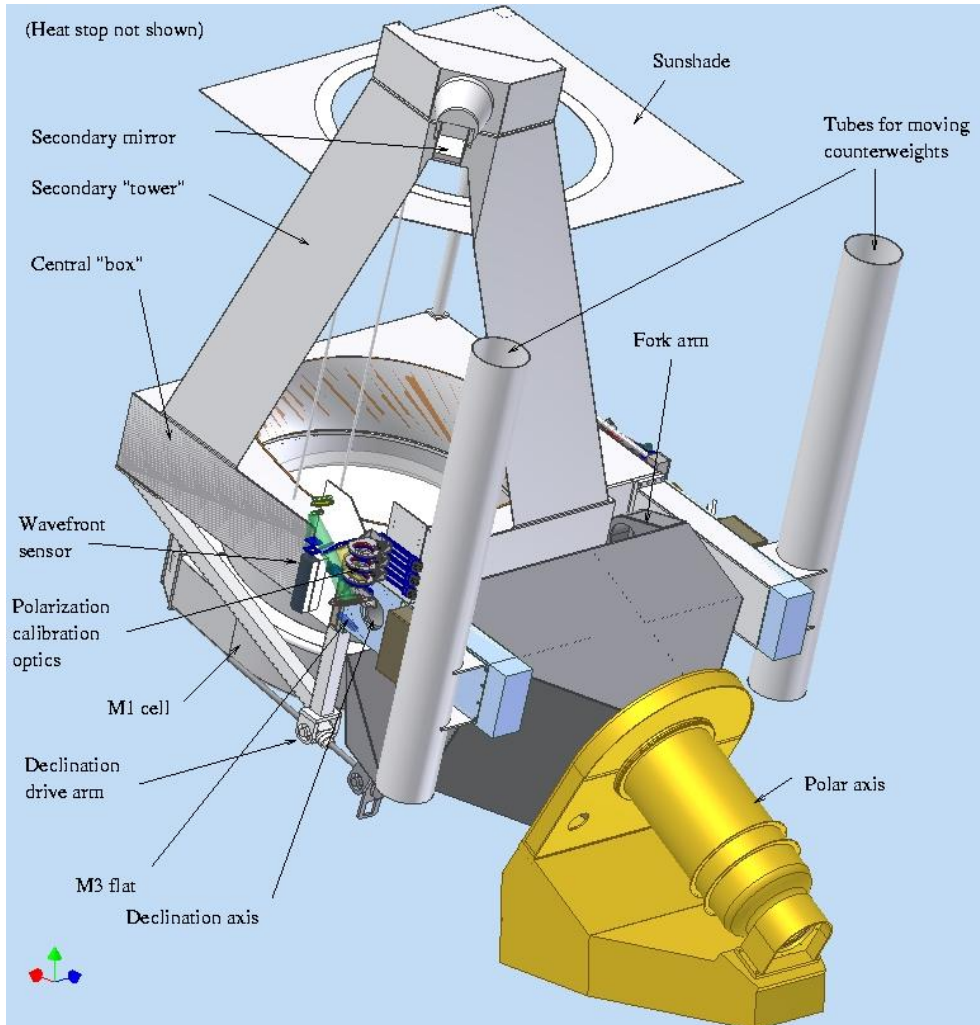

- ❖ All reflecting, off-axis Gregory optical configuration
- ❖ PM: off-axis 1.6 m clear aperture (1.7 m blank) with  $f/2.4$
- ❖ Figuring PM to 16 nm rms
- ❖ Effective focal length: 83.2 m ( $F/52$  at Gregorian focus and  $F/28$  at Coudé focus)
- ❖ FOV: 2' in prime focus
- ❖ Wavelength range from 400 nm to NIR in Coudé lab with AO
- ❖ Integrated active optics (ao) and adaptive optics (AO)
- ❖ Quasi-static telescope alignment
- ❖ Diffraction limited: 0.06" @ 500 nm and 0.2" @ 1.56  $\mu\text{m}$  with AO
- ❖ Polarization calibration optics immediately before M3
- ❖ Facility-class instruments

# 2<sup>nd</sup> Generation AO: AO-308



- ❖ AO-308 is operational, AO-308 is a collaboration between BBSO and NSO
- ❖ Shack Hartmann WFS with 308 sub-apertures (AO-308): 20 sub-apertures across the NST primary mirror
- ❖ Xinetics Deformable Mirror with 357 actuators and 5 mm spacing
- ❖ Phantom V.7.3 camera with a frame rate of 2000 Hz for 400 by 400 pixel sub-array
- ❖ Bitware TigerSHARC Boards with 16 digital signal processors (DSPs)
- ❖ Expected Closed-loop Bandwidth: 120 Hz
- ❖ Acquire diffraction limited imaging over the telescope's full range of operation

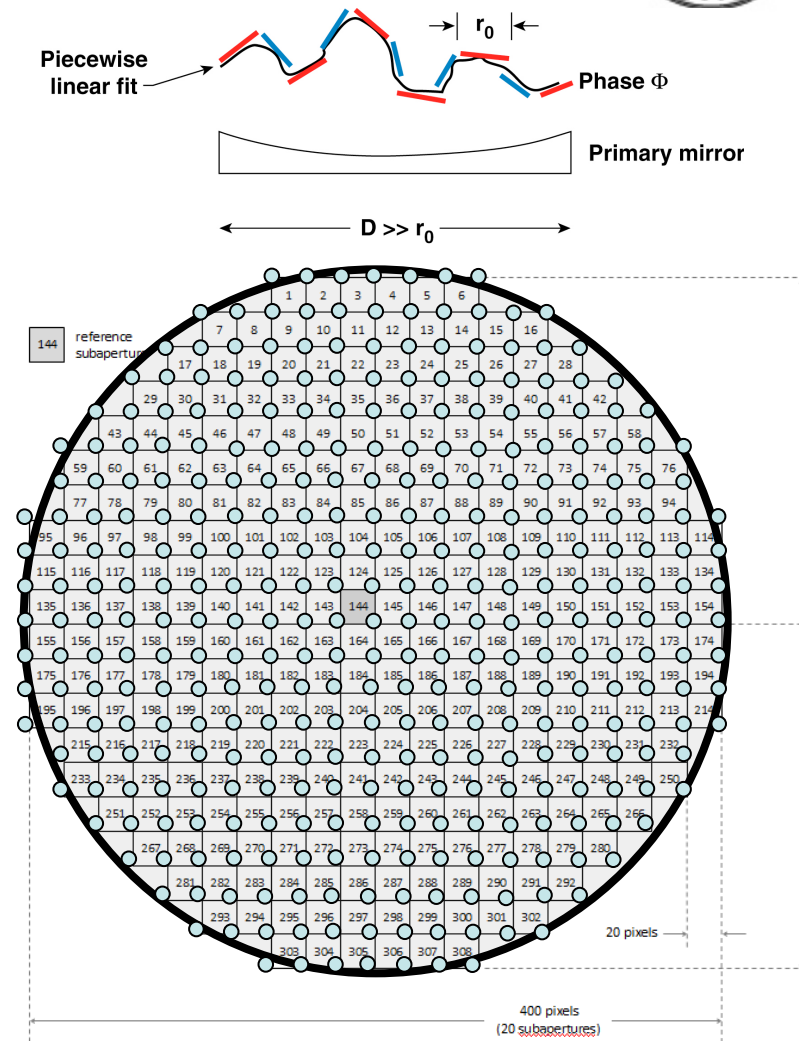



# 3<sup>rd</sup> Generation AO: MCAO

- ❖ Multi-Conjugate AO (MCAO) is a collaboration with KIS & NSO
- ❖ Two Shack Hartmann wavefront sensor for narrow and wide field measurement
- ❖ Three DMs with 357 actuators conjugated to ground, 3-5 km, and 6-9 km
- ❖ Multi-CPU parallel computation
- ❖ High speed camera with frame rate of 2000 Hz
- ❖ Closed-loop Bandwidth: 120 Hz
- ❖ Expand field of view of diffraction limited observations to  $\sim 1'$  in the visible

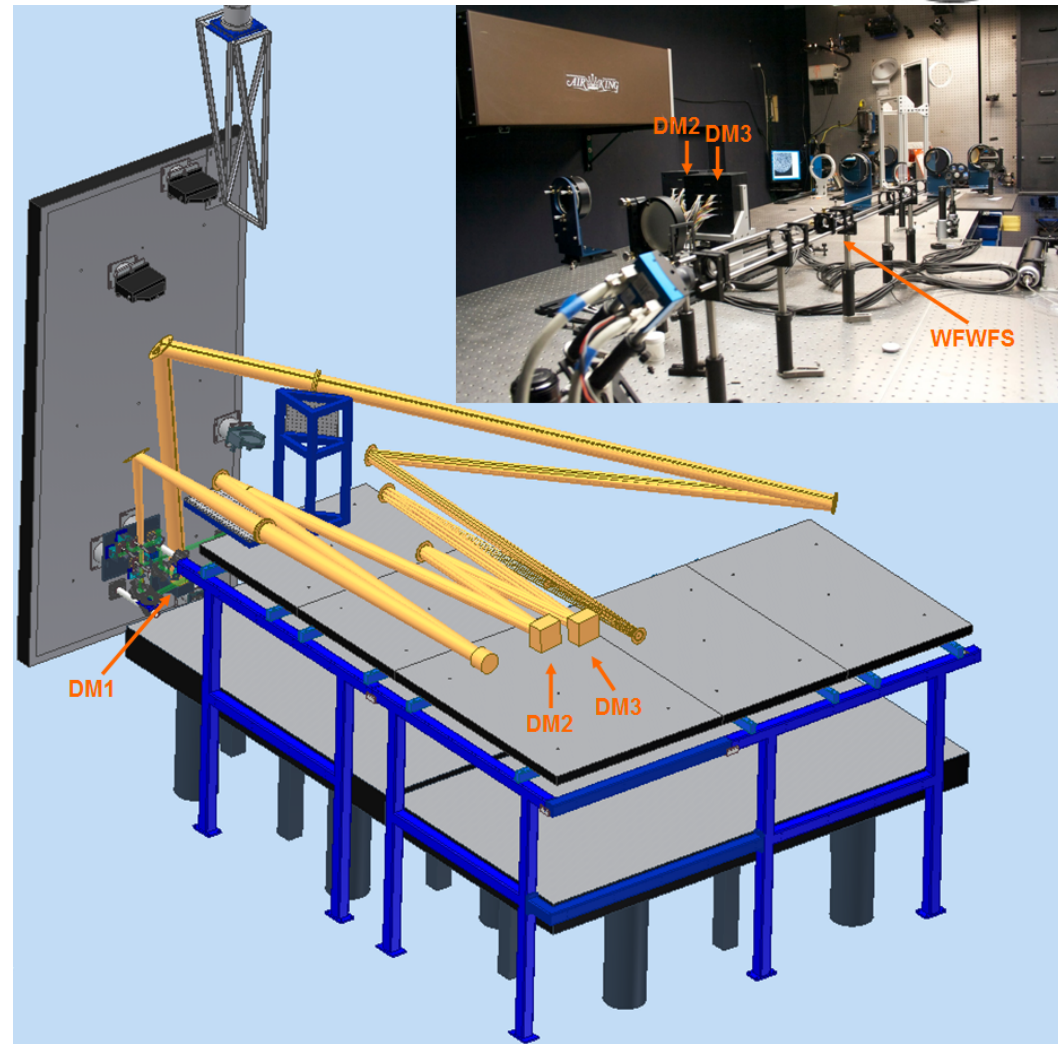



# NST Scientific Instruments

- ❖ Adaptive Optics System (AO:  
**AO-76, AO-308, MCAO**)  
– **SPIE.9148.100, SPIE.9148.193**
- ❖ Visible Imaging Spectrometer  
(**VIS**) – **SPIE.9147.15**
- ❖ Near InfraRed Imaging Spectro-  
polarimeters (**IRIM, NIRIS**)  
– **SPIE.9147.127**
- ❖ Cryogenic Infrared Spectrograph  
(**CYRA**) – **SPIE.9147.129**
- ❖ Broad-band Filter Imager (**BFI**)
- ❖ Fast Imaging Solar Spectrograph  
(**FISS**)

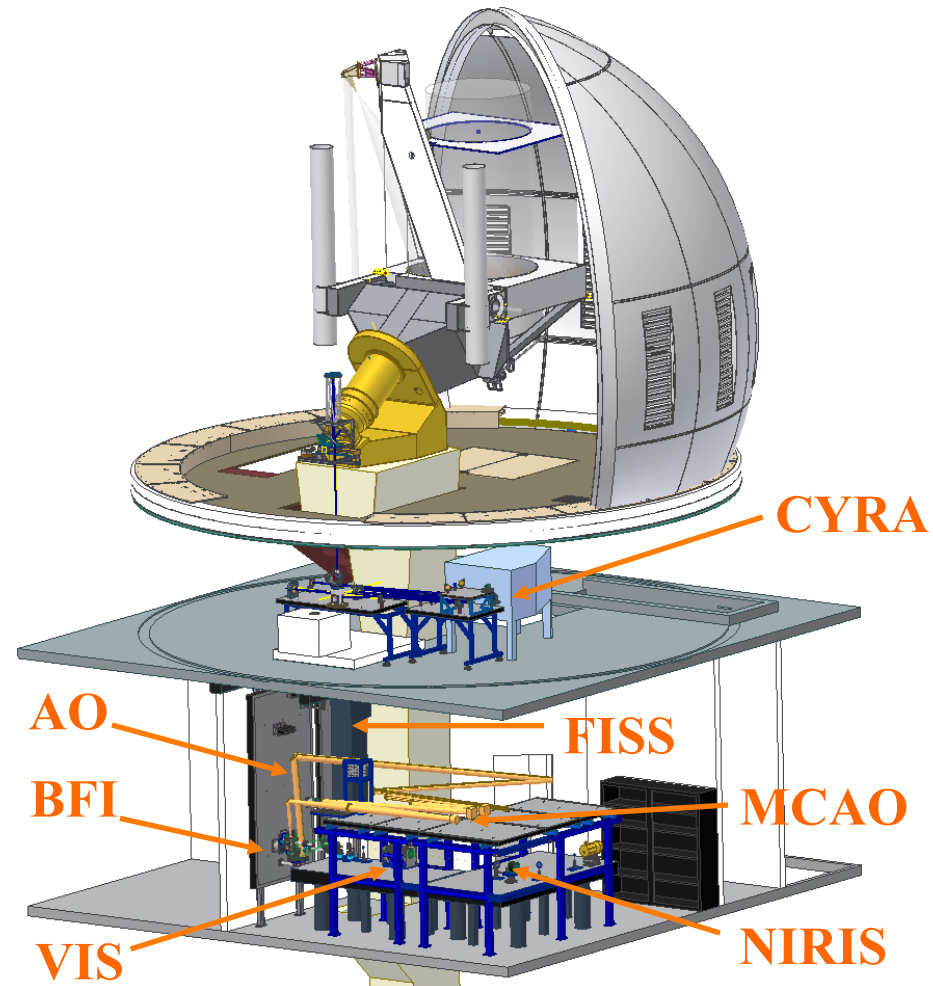

# 1.5 meter GREGOR

- ❖ 2001: GREGOR consortium established
- ❖ 2003: Decommissioning of 45 cm Gregory Coudé Telescope
- ❖ 2004 – 2011: Design, fabrication and integration of dome, telescope structure, optics, instruments, control and cooling system
- ❖ 2013: Science verification observations
- ❖ 2014 – 2015: Early Science Phase (consortium only)

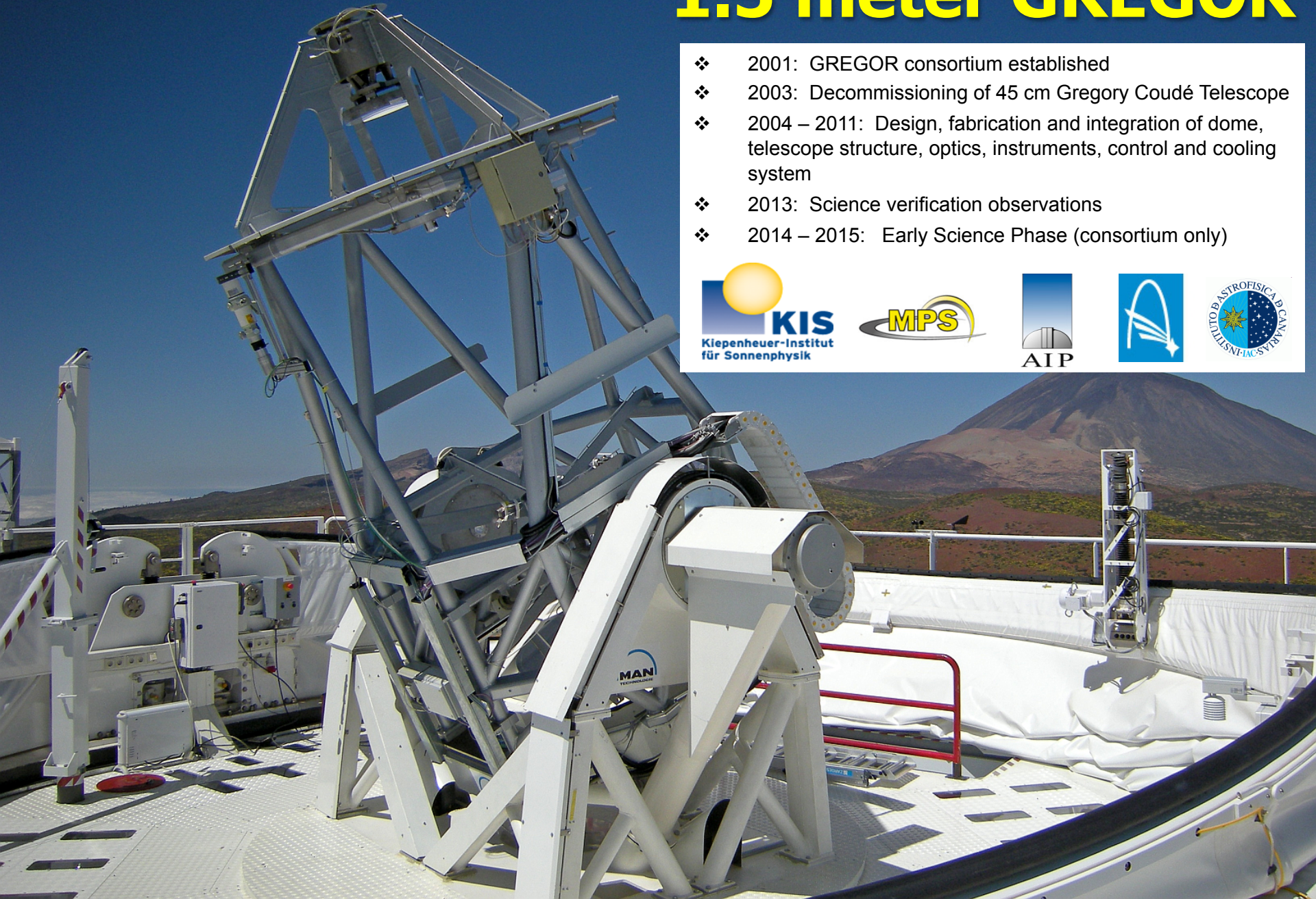

# GREGOR Overview

- Optical Configuration
  - Gregory (3 on-axis mirrors)
  - effective focal length 55 m ( $F/38$ )
  - nominal field-of-view 150 arcsec
- Primary mirror
  - 1.5 m aperture
  - focal length 2500 mm
  - light-weighted Zerodur
  - active cooling
- Wavelength coverage
  - 350 nm – NIR (thermal IR possible)
- Foldable dome
- Integrated adaptive optics
- Three post-focus instruments

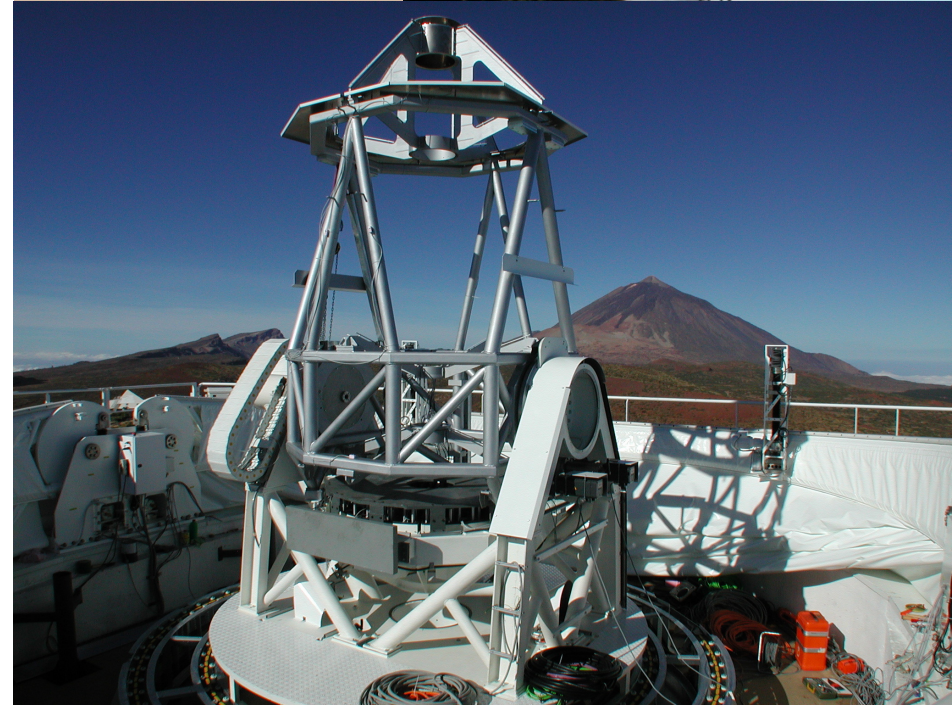
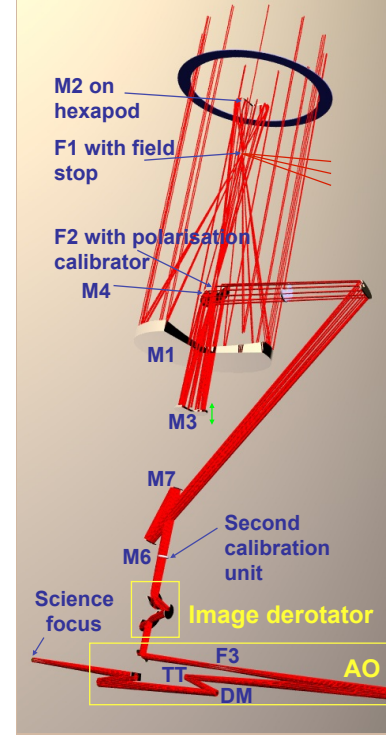

*Courtesy : O. von der Lühe*

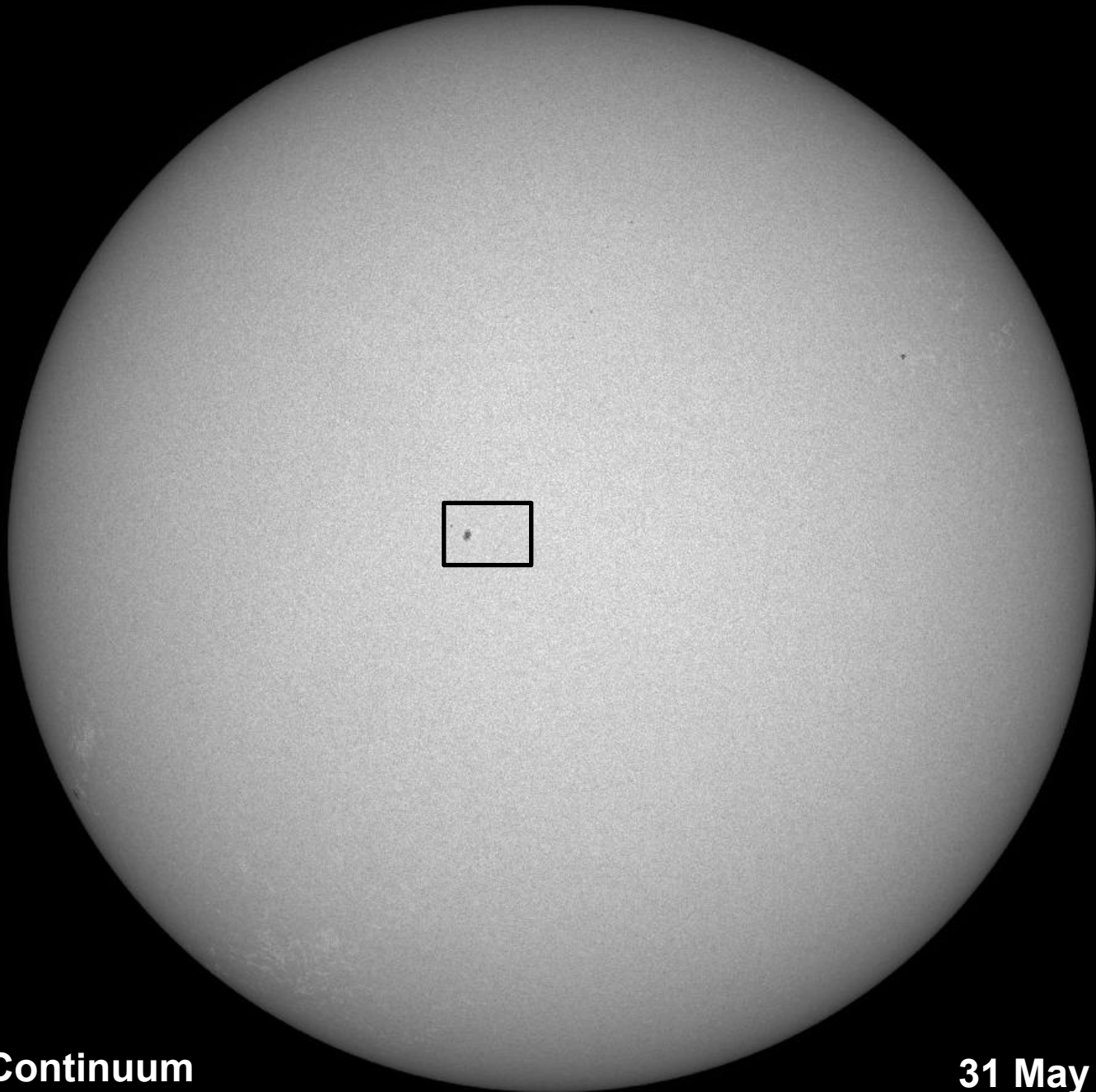

**SDO HMI Continuum**

**31 May 2013 12:35**



*Courtesy : O. von der Lühe*

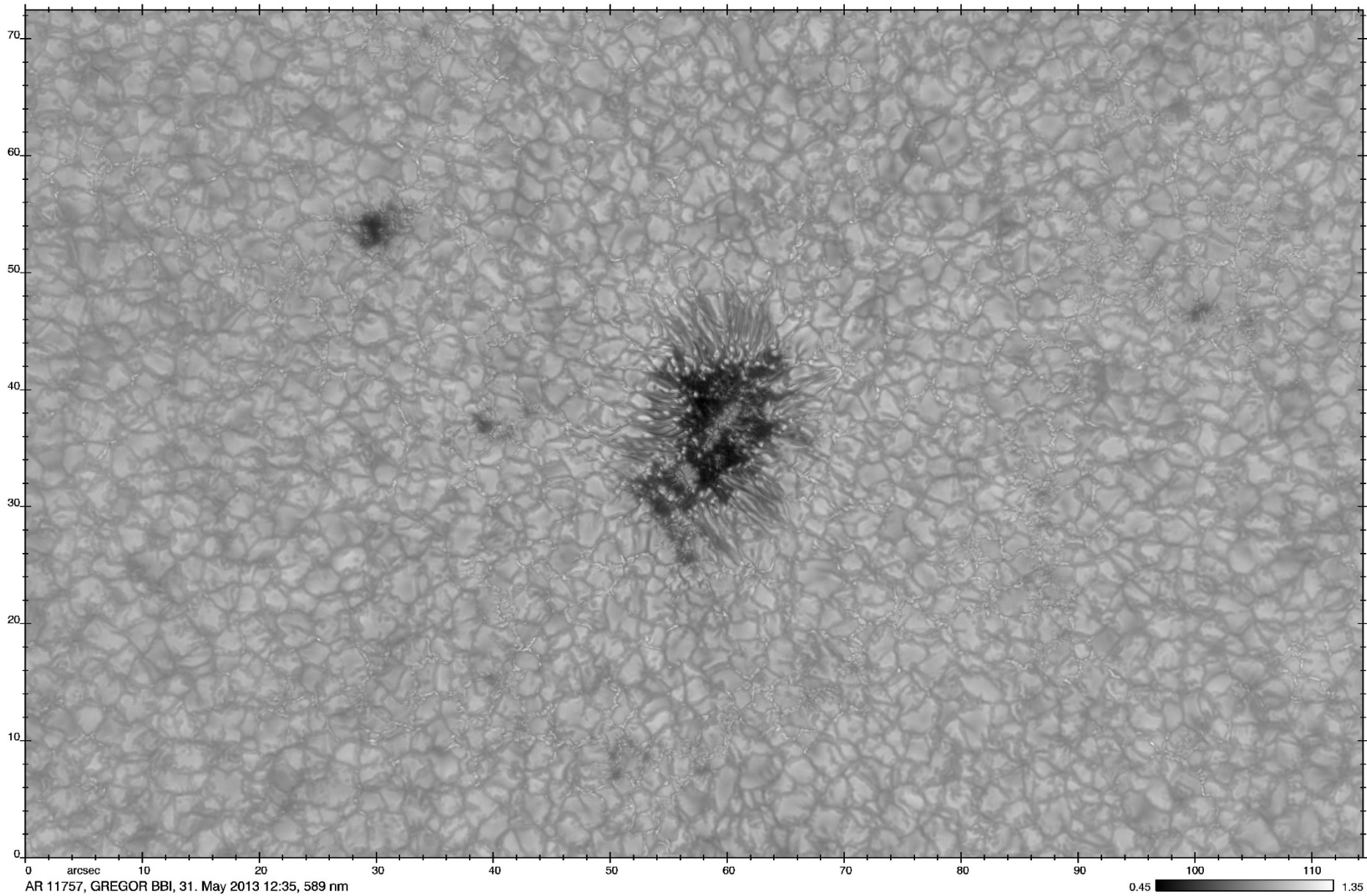

AR 11757, GREGOR BBI, 31. May 2013 12:35, 589 nm

0.45 1.35

NOAA AR11757, GREGOR Broad-Band Imager, 589 nm, 20s, 4008x2672 px, 0".03 / px

*Courtesy : O. von der Lühe*

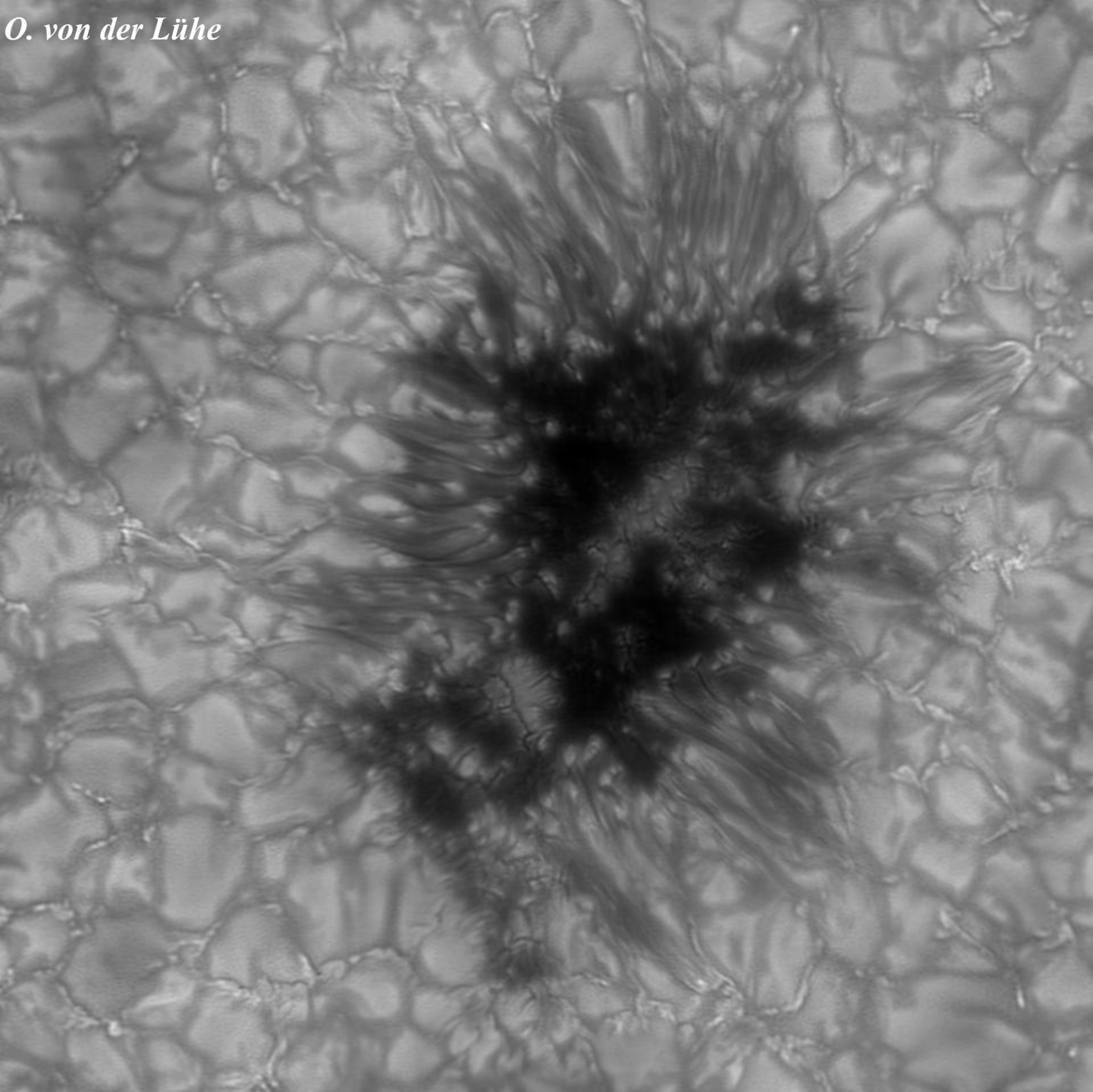

Courtesy : O. von der Lühe

# GRating Infrared Spectrograph (GRIS)

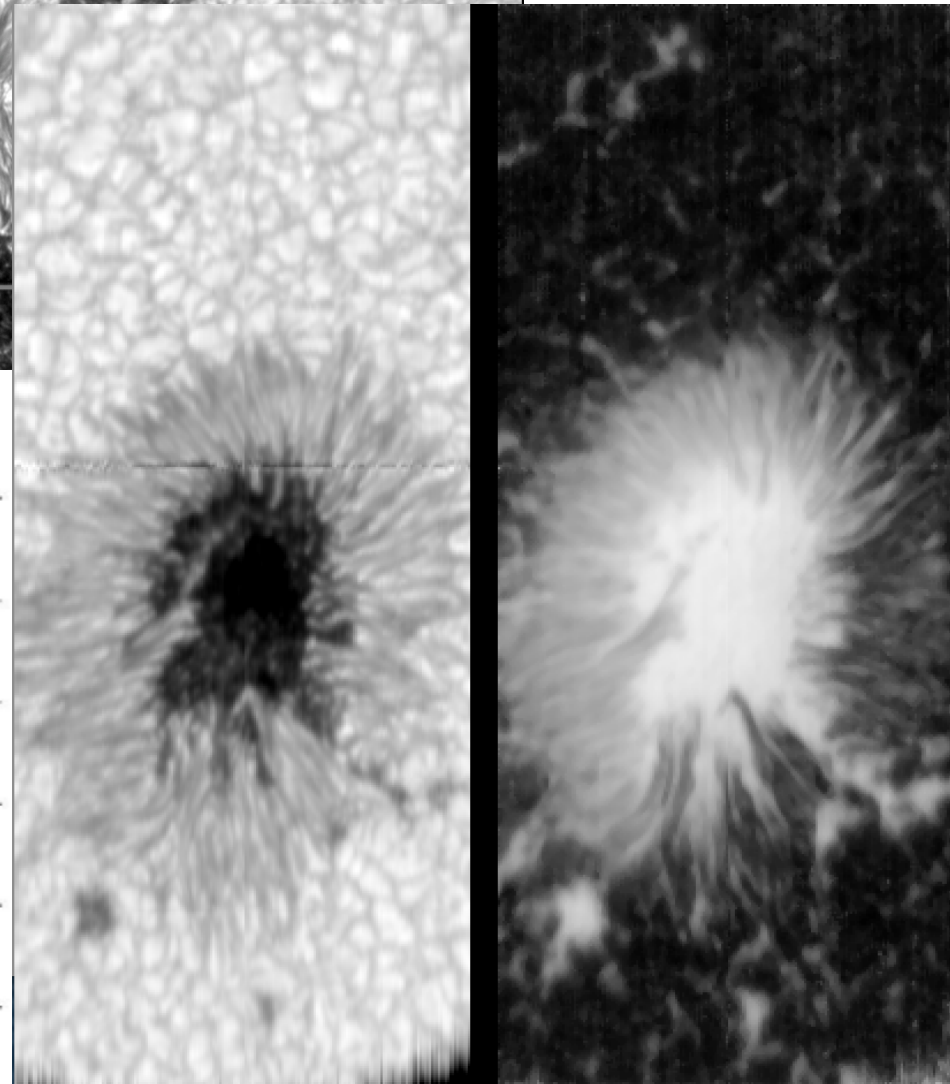
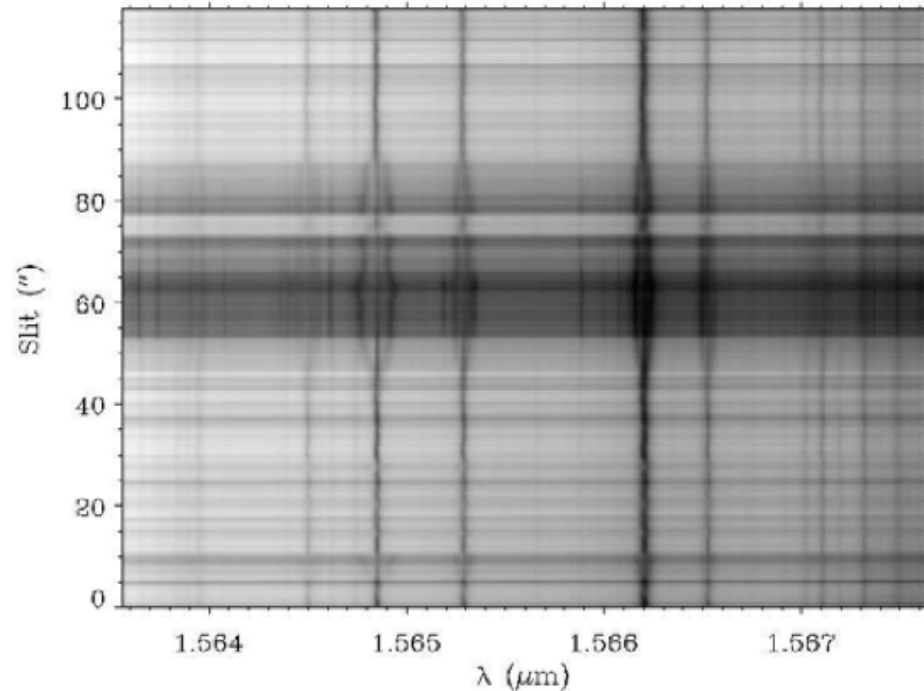
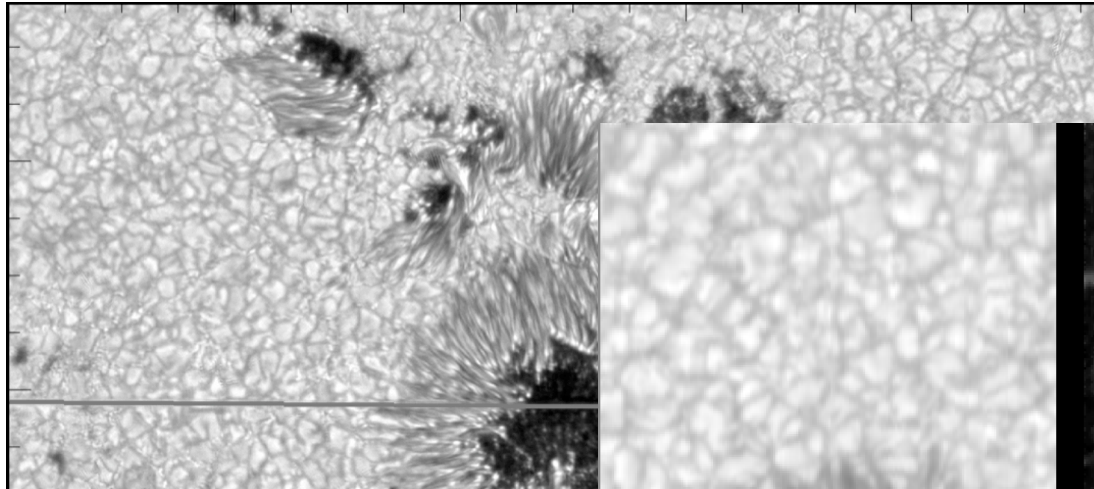

# 1 meter NVST

- Altitude: **1720 m**
- Longitude: **102°57'11" E**
- Latitude: **24°34'47" N**
- Sunshine duration: **> 2200 hrs/yr**
- Average wind velocity: **~ 6 m/s**
- Integrated water vapor : **~ 11 mm**  
(one-year average)
- Average  $r_0$ : **10 cm** (one-year average)
- First light Scientific results: 2012



Courtesy : Z. Liu

Moveable dome

Telescope & wind screen

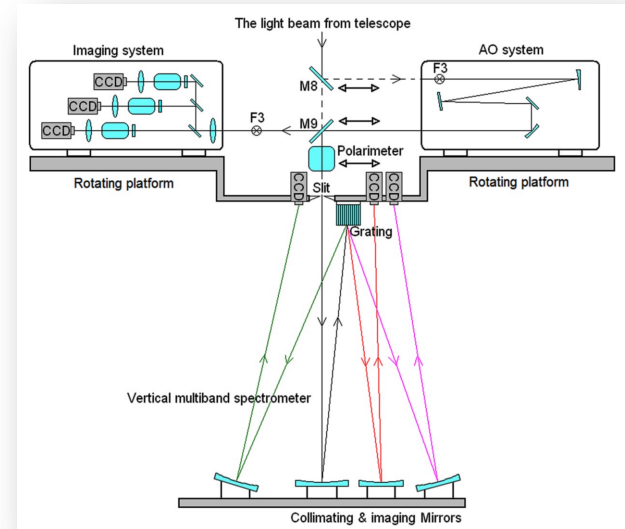
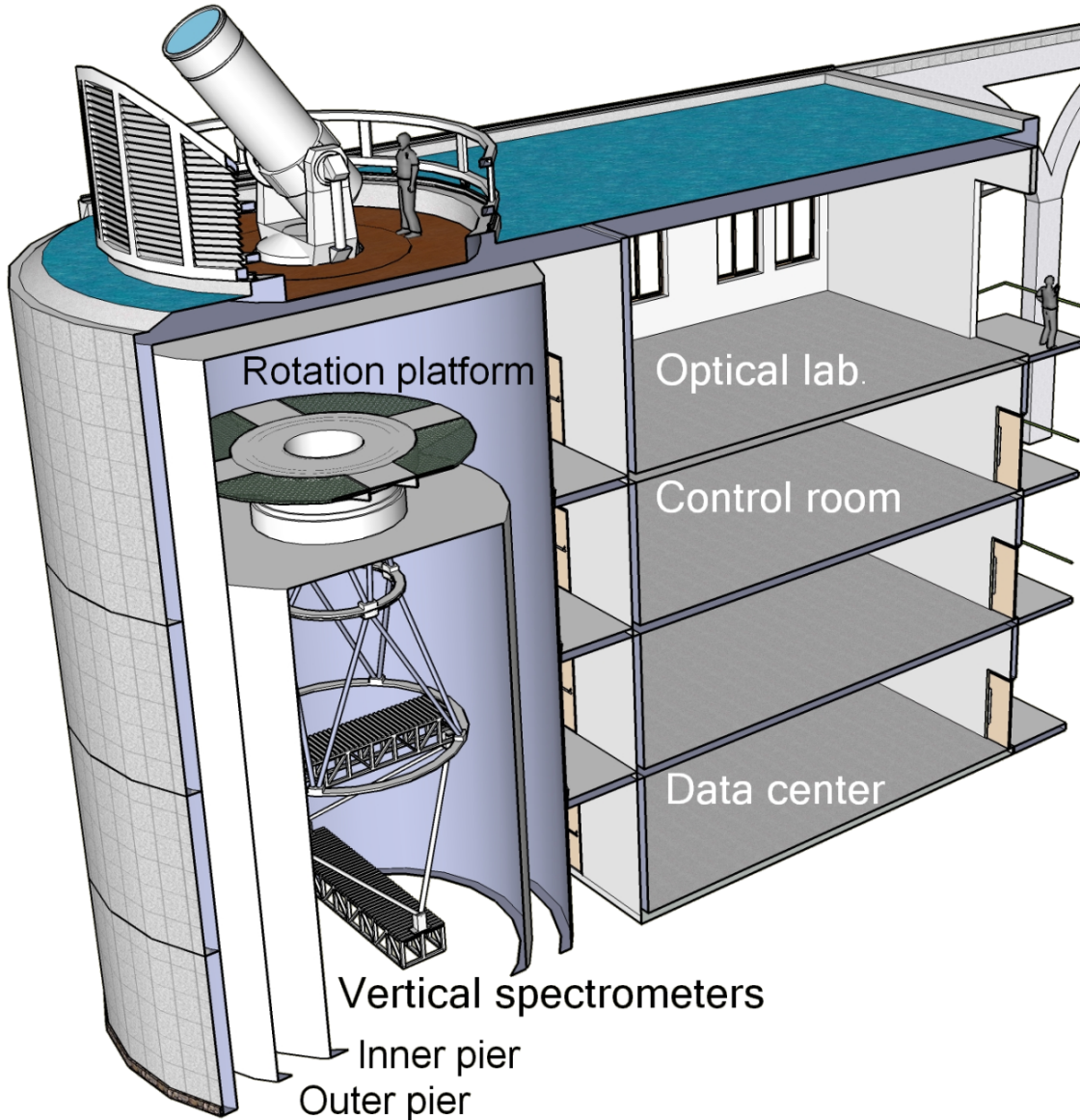

Courtesy : Z. Liu

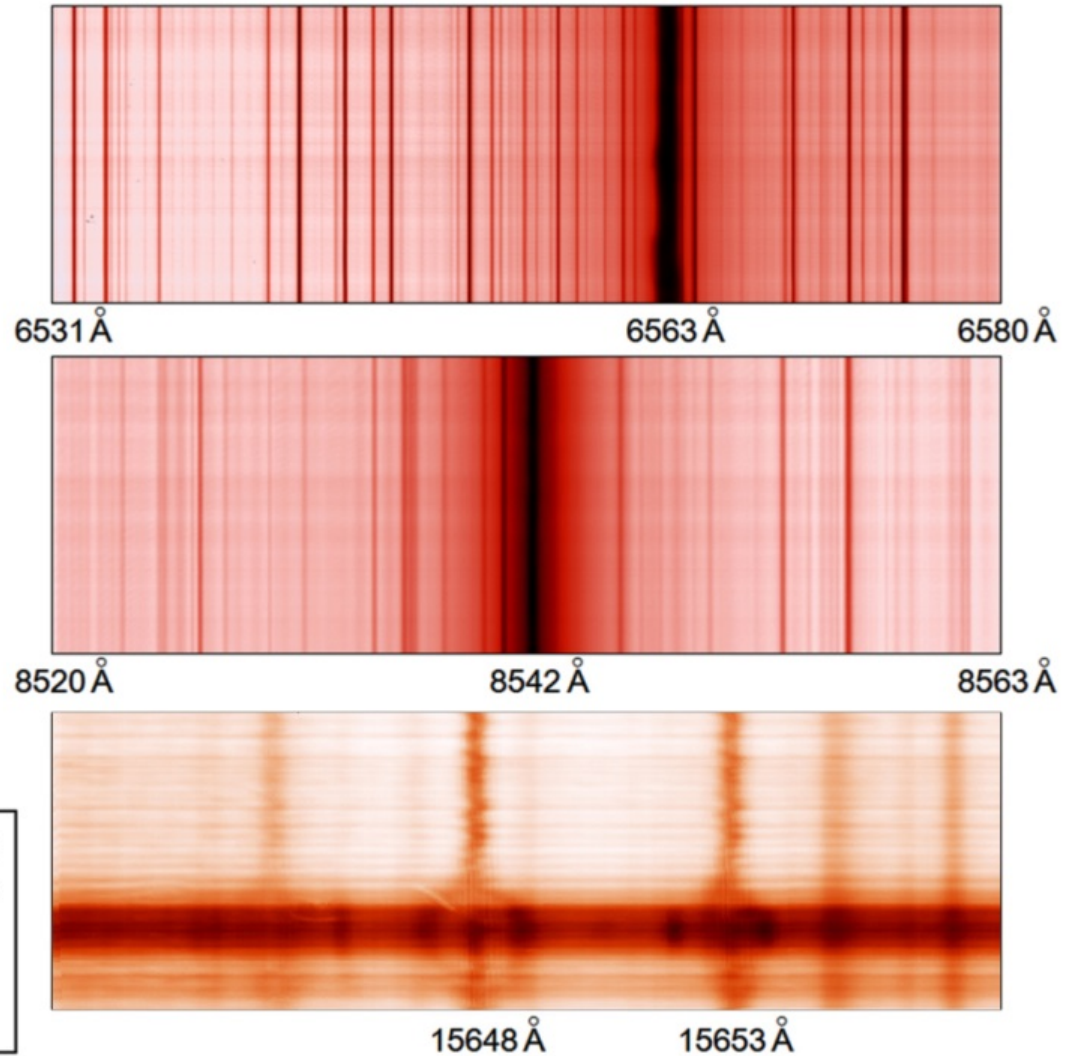
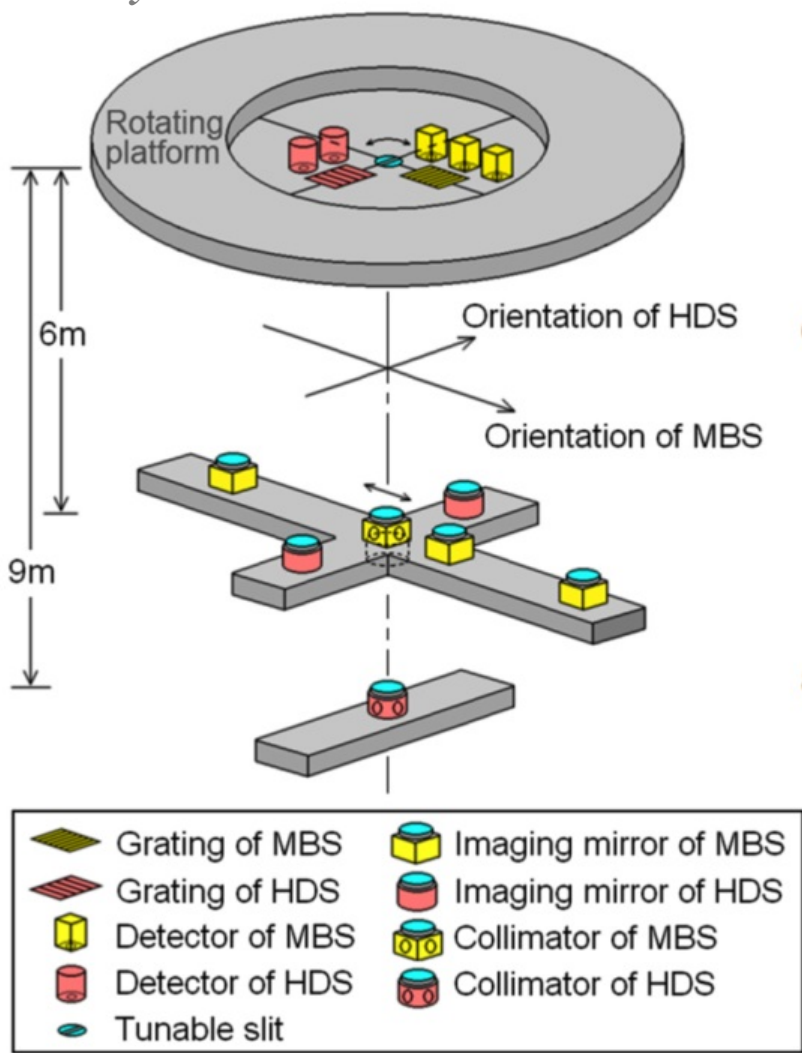

- Spectrometers (*left*, not to scale) and some observational results (*right*). The spectra of a quiet region around 656.3 nm and 854.2 nm observed by multi-band spectrometer. The spectra of a small sunspot around 1564.8 nm observed by high dispersion spectrometer.

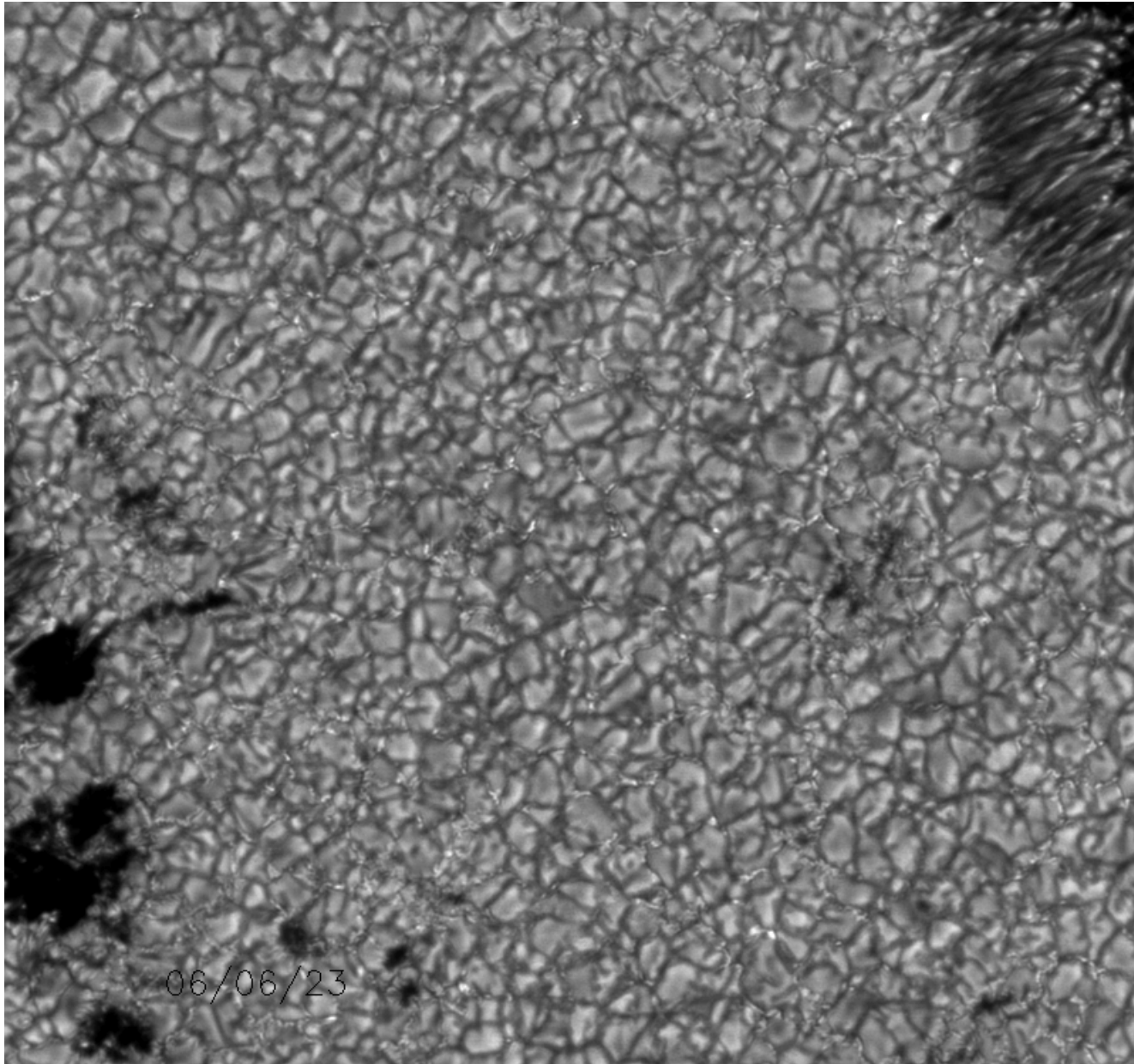

**High resolution movie of  
AR11554 taken with NVST at TiO 706 nm** *Courtesy : Z. Liu*

*Courtesy : Z. Liu*

# Unprecedented high resolution limb observation taken with NVST







# Technical Challenges for Next Generation Solar Telescopes

## ❖ **Wavefront Control**

- ❖ wavefront sensing, active optics (ao), Visible AO, MCAO .....

## ❖ **Thermal Control**

- ❖ Telescope prime focus, all optics, enclosure, coude lab, interfaces ...

## ❖ **Scattered Light Control**

- ❖ Spider diffraction, micro roughness, dust, mirror cleaning ...

**Without AO**

**With AO**

**With MCAO**

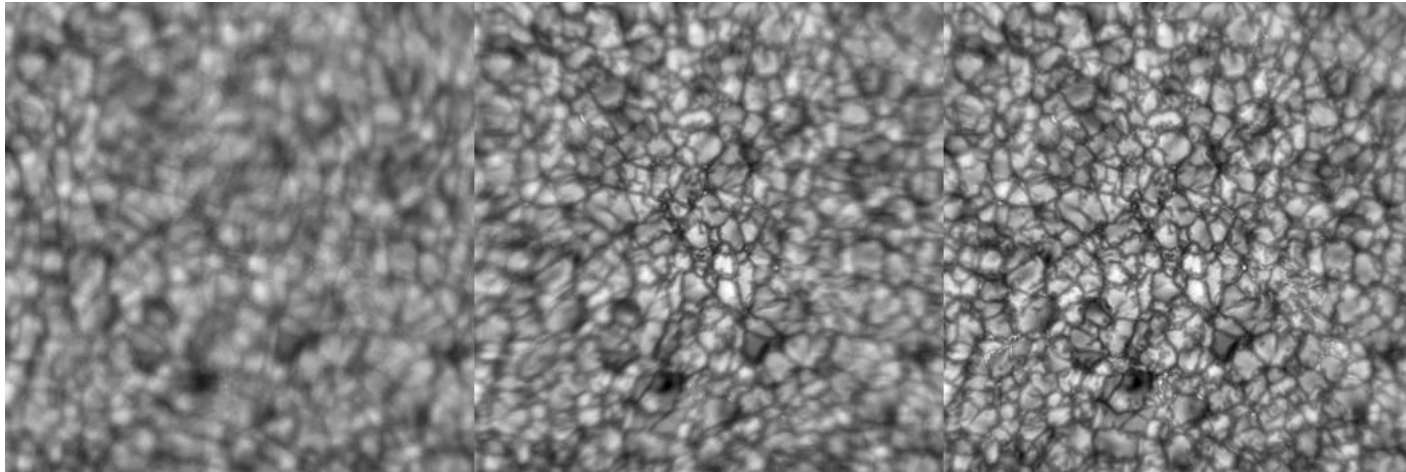

# Technical Challenges for Next Generation Solar Telescopes (cont.)



## ❖ **Telescope Optics**

- ❖ On-axis: Light-weight mirror polishing, metrology, alignment ...
- ❖ Off-axis: Primary mirror figuring, metrology, alignment ...
- ❖ Segmented: on-focus and in-phase ...

## ❖ **High Precision Polarimetry**

- ❖ Integrated into optical path, accurate polarization calibration ...

## ❖ **Near, Mid and Far Infrared**

- ❖ Structure design, cryogenic technique, FPA ....

## ❖ **Instrumentation**

- ❖ Multi-FPIs, multi-slits and fiber spectrograph, multi-instrument operations

## ❖ **Data Handling**

- ❖ Big data, collection, storage, distribution ....

## ❖ **Control Software**

## ❖ **Keep your sanity**



# Summary

- ❖ Large solar telescopes hold promise of revolutionizing our knowledge of the solar atmosphere and its dynamics.
- ❖ With several large aperture optical/IR telescopes just coming on-line, or scheduled for the near future, solar physics is on the verge of a quantum leap in observational capabilities.
- ❖ Current and next generation Chinese large ground-based solar telescopes are/will be playing a critical roles in solar high resolution, non-sunset observations.



76 cm DST



BBSO 65 cm



HSOS 60 cm



1.6 m NST  
USA 2009

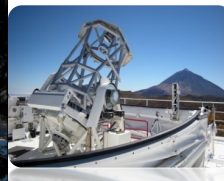

1.5 m GREGOR  
Germany 2014



1 m NVST  
China 2012

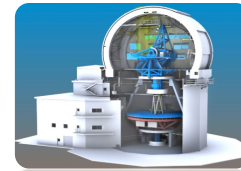

4 m DKIST  
USA 2019

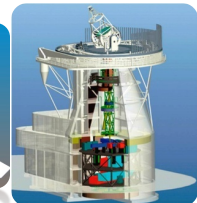

4 m EST EUR

