

**02 INFORMATION ABOUT PRINCIPAL INVESTIGATORS/PROJECT DIRECTORS(PI/PD) and  
co-PRINCIPAL INVESTIGATORS/co-PROJECT DIRECTORS**

---

Submit only ONE copy of this form for each PI/PD and co-PI/PD identified on the proposal. The form(s) should be attached to the original proposal as specified in GPG Section II.B. Submission of this information is voluntary and is not a precondition of award. This information will not be disclosed to external peer reviewers. **DO NOT INCLUDE THIS FORM WITH ANY OF THE OTHER COPIES OF YOUR PROPOSAL AS THIS MAY COMPROMISE THE CONFIDENTIALITY OF THE INFORMATION.**

---

**PI/PD Name:** Philip Goode

**Gender:**  Male  Female  
**Ethnicity:** (Choose one response)  Hispanic or Latino  Not Hispanic or Latino

**Race:**  
(Select one or more)  
 American Indian or Alaska Native  
 Asian  
 Black or African American  
 Native Hawaiian or Other Pacific Islander  
 White

**Disability Status:**  
(Select one or more)  
 Hearing Impairment  
 Visual Impairment  
 Mobility/Orthopedic Impairment  
 Other  
 None

**Citizenship:** (Choose one)  U.S. Citizen  Permanent Resident  Other non-U.S. Citizen

**Check here if you do not wish to provide any or all of the above information (excluding PI/PD name):**

**REQUIRED: Check here if you are currently serving (or have previously served) as a PI, co-PI or PD on any federally funded project**

---

**Ethnicity Definition:**

**Hispanic or Latino.** A person of Mexican, Puerto Rican, Cuban, South or Central American, or other Spanish culture or origin, regardless of race.

**Race Definitions:**

**American Indian or Alaska Native.** A person having origins in any of the original peoples of North and South America (including Central America), and who maintains tribal affiliation or community attachment.

**Asian.** A person having origins in any of the original peoples of the Far East, Southeast Asia, or the Indian subcontinent including, for example, Cambodia, China, India, Japan, Korea, Malaysia, Pakistan, the Philippine Islands, Thailand, and Vietnam.

**Black or African American.** A person having origins in any of the black racial groups of Africa.

**Native Hawaiian or Other Pacific Islander.** A person having origins in any of the original peoples of Hawaii, Guam, Samoa, or other Pacific Islands.

**White.** A person having origins in any of the original peoples of Europe, the Middle East, or North Africa.

---

**WHY THIS INFORMATION IS BEING REQUESTED:**

The Federal Government has a continuing commitment to monitor the operation of its review and award processes to identify and address any inequities based on gender, race, ethnicity, or disability of its proposed PIs/PDs. To gather information needed for this important task, the proposer should submit a single copy of this form for each identified PI/PD with each proposal. Submission of the requested information is voluntary and will not affect the organization's eligibility for an award. However, information not submitted will seriously undermine the statistical validity, and therefore the usefulness, of information received from others. Any individual not wishing to submit some or all the information should check the box provided for this purpose. (The exceptions are the PI/PD name and the information about prior Federal support, the last question above.)

Collection of this information is authorized by the NSF Act of 1950, as amended, 42 U.S.C. 1861, et seq. Demographic data allows NSF to gauge whether our programs and other opportunities in science and technology are fairly reaching and benefiting everyone regardless of demographic category; to ensure that those in under-represented groups have the same knowledge of and access to programs and other research and educational opportunities; and to assess involvement of international investigators in work supported by NSF. The information may be disclosed to government contractors, experts, volunteers and researchers to complete assigned work; and to other government agencies in order to coordinate and assess programs. The information may be added to the Reviewer file and used to select potential candidates to serve as peer reviewers or advisory committee members. See Systems of Records, NSF-50, "Principal Investigator/Proposal File and Associated Records", 63 Federal Register 267 (January 5, 1998), and NSF-51, "Reviewer/Proposal File and Associated Records", 63 Federal Register 268 (January 5, 1998).

**02 INFORMATION ABOUT PRINCIPAL INVESTIGATORS/PROJECT DIRECTORS(PI/PD) and  
co-PRINCIPAL INVESTIGATORS/co-PROJECT DIRECTORS**

---

Submit only ONE copy of this form for each PI/PD and co-PI/PD identified on the proposal. The form(s) should be attached to the original proposal as specified in GPG Section II.B. Submission of this information is voluntary and is not a precondition of award. This information will not be disclosed to external peer reviewers. **DO NOT INCLUDE THIS FORM WITH ANY OF THE OTHER COPIES OF YOUR PROPOSAL AS THIS MAY COMPROMISE THE CONFIDENTIALITY OF THE INFORMATION.**

---

**PI/PD Name:** Thomas R Ayres

**Gender:**  Male  Female  
**Ethnicity:** (Choose one response)  Hispanic or Latino  Not Hispanic or Latino

**Race:**  
(Select one or more)  
 American Indian or Alaska Native  
 Asian  
 Black or African American  
 Native Hawaiian or Other Pacific Islander  
 White

**Disability Status:**  
(Select one or more)  
 Hearing Impairment  
 Visual Impairment  
 Mobility/Orthopedic Impairment  
 Other  
 None

**Citizenship:** (Choose one)  U.S. Citizen  Permanent Resident  Other non-U.S. Citizen

**Check here if you do not wish to provide any or all of the above information (excluding PI/PD name):**

**REQUIRED: Check here if you are currently serving (or have previously served) as a PI, co-PI or PD on any federally funded project**

---

**Ethnicity Definition:**

**Hispanic or Latino.** A person of Mexican, Puerto Rican, Cuban, South or Central American, or other Spanish culture or origin, regardless of race.

**Race Definitions:**

**American Indian or Alaska Native.** A person having origins in any of the original peoples of North and South America (including Central America), and who maintains tribal affiliation or community attachment.

**Asian.** A person having origins in any of the original peoples of the Far East, Southeast Asia, or the Indian subcontinent including, for example, Cambodia, China, India, Japan, Korea, Malaysia, Pakistan, the Philippine Islands, Thailand, and Vietnam.

**Black or African American.** A person having origins in any of the black racial groups of Africa.

**Native Hawaiian or Other Pacific Islander.** A person having origins in any of the original peoples of Hawaii, Guam, Samoa, or other Pacific Islands.

**White.** A person having origins in any of the original peoples of Europe, the Middle East, or North Africa.

---

**WHY THIS INFORMATION IS BEING REQUESTED:**

The Federal Government has a continuing commitment to monitor the operation of its review and award processes to identify and address any inequities based on gender, race, ethnicity, or disability of its proposed PIs/PDs. To gather information needed for this important task, the proposer should submit a single copy of this form for each identified PI/PD with each proposal. Submission of the requested information is voluntary and will not affect the organization's eligibility for an award. However, information not submitted will seriously undermine the statistical validity, and therefore the usefulness, of information received from others. Any individual not wishing to submit some or all the information should check the box provided for this purpose. (The exceptions are the PI/PD name and the information about prior Federal support, the last question above.)

Collection of this information is authorized by the NSF Act of 1950, as amended, 42 U.S.C. 1861, et seq. Demographic data allows NSF to gauge whether our programs and other opportunities in science and technology are fairly reaching and benefiting everyone regardless of demographic category; to ensure that those in under-represented groups have the same knowledge of and access to programs and other research and educational opportunities; and to assess involvement of international investigators in work supported by NSF. The information may be disclosed to government contractors, experts, volunteers and researchers to complete assigned work; and to other government agencies in order to coordinate and assess programs. The information may be added to the Reviewer file and used to select potential candidates to serve as peer reviewers or advisory committee members. See Systems of Records, NSF-50, "Principal Investigator/Proposal File and Associated Records", 63 Federal Register 267 (January 5, 1998), and NSF-51, "Reviewer/Proposal File and Associated Records", 63 Federal Register 268 (January 5, 1998).

**02 INFORMATION ABOUT PRINCIPAL INVESTIGATORS/PROJECT DIRECTORS(PI/PD) and  
co-PRINCIPAL INVESTIGATORS/co-PROJECT DIRECTORS**

---

Submit only ONE copy of this form for each PI/PD and co-PI/PD identified on the proposal. The form(s) should be attached to the original proposal as specified in GPG Section II.B. Submission of this information is voluntary and is not a precondition of award. This information will not be disclosed to external peer reviewers. **DO NOT INCLUDE THIS FORM WITH ANY OF THE OTHER COPIES OF YOUR PROPOSAL AS THIS MAY COMPROMISE THE CONFIDENTIALITY OF THE INFORMATION.**

---

**PI/PD Name:** Wenda Cao

**Gender:**  Male  Female  
**Ethnicity:** (Choose one response)  Hispanic or Latino  Not Hispanic or Latino

**Race:**  
(Select one or more)  American Indian or Alaska Native  
 Asian  
 Black or African American  
 Native Hawaiian or Other Pacific Islander  
 White

**Disability Status:**  
(Select one or more)  Hearing Impairment  
 Visual Impairment  
 Mobility/Orthopedic Impairment  
 Other  
 None

**Citizenship:** (Choose one)  U.S. Citizen  Permanent Resident  Other non-U.S. Citizen

**Check here if you do not wish to provide any or all of the above information (excluding PI/PD name):**

**REQUIRED: Check here if you are currently serving (or have previously served) as a PI, co-PI or PD on any federally funded project**

---

**Ethnicity Definition:**

**Hispanic or Latino.** A person of Mexican, Puerto Rican, Cuban, South or Central American, or other Spanish culture or origin, regardless of race.

**Race Definitions:**

**American Indian or Alaska Native.** A person having origins in any of the original peoples of North and South America (including Central America), and who maintains tribal affiliation or community attachment.

**Asian.** A person having origins in any of the original peoples of the Far East, Southeast Asia, or the Indian subcontinent including, for example, Cambodia, China, India, Japan, Korea, Malaysia, Pakistan, the Philippine Islands, Thailand, and Vietnam.

**Black or African American.** A person having origins in any of the black racial groups of Africa.

**Native Hawaiian or Other Pacific Islander.** A person having origins in any of the original peoples of Hawaii, Guam, Samoa, or other Pacific Islands.

**White.** A person having origins in any of the original peoples of Europe, the Middle East, or North Africa.

---

**WHY THIS INFORMATION IS BEING REQUESTED:**

The Federal Government has a continuing commitment to monitor the operation of its review and award processes to identify and address any inequities based on gender, race, ethnicity, or disability of its proposed PIs/PDs. To gather information needed for this important task, the proposer should submit a single copy of this form for each identified PI/PD with each proposal. Submission of the requested information is voluntary and will not affect the organization's eligibility for an award. However, information not submitted will seriously undermine the statistical validity, and therefore the usefulness, of information received from others. Any individual not wishing to submit some or all the information should check the box provided for this purpose. (The exceptions are the PI/PD name and the information about prior Federal support, the last question above.)

Collection of this information is authorized by the NSF Act of 1950, as amended, 42 U.S.C. 1861, et seq. Demographic data allows NSF to gauge whether our programs and other opportunities in science and technology are fairly reaching and benefiting everyone regardless of demographic category; to ensure that those in under-represented groups have the same knowledge of and access to programs and other research and educational opportunities; and to assess involvement of international investigators in work supported by NSF. The information may be disclosed to government contractors, experts, volunteers and researchers to complete assigned work; and to other government agencies in order to coordinate and assess programs. The information may be added to the Reviewer file and used to select potential candidates to serve as peer reviewers or advisory committee members. See Systems of Records, NSF-50, "Principal Investigator/Proposal File and Associated Records", 63 Federal Register 267 (January 5, 1998), and NSF-51, "Reviewer/Proposal File and Associated Records", 63 Federal Register 268 (January 5, 1998).

**02 INFORMATION ABOUT PRINCIPAL INVESTIGATORS/PROJECT DIRECTORS(PI/PD) and  
co-PRINCIPAL INVESTIGATORS/co-PROJECT DIRECTORS**

---

Submit only ONE copy of this form for each PI/PD and co-PI/PD identified on the proposal. The form(s) should be attached to the original proposal as specified in GPG Section II.B. Submission of this information is voluntary and is not a precondition of award. This information will not be disclosed to external peer reviewers. **DO NOT INCLUDE THIS FORM WITH ANY OF THE OTHER COPIES OF YOUR PROPOSAL AS THIS MAY COMPROMISE THE CONFIDENTIALITY OF THE INFORMATION.**

---

**PI/PD Name:** Roy Coulter

**Gender:**  Male  Female  
**Ethnicity:** (Choose one response)  Hispanic or Latino  Not Hispanic or Latino

**Race:**  
(Select one or more)  
 American Indian or Alaska Native  
 Asian  
 Black or African American  
 Native Hawaiian or Other Pacific Islander  
 White

**Disability Status:**  
(Select one or more)  
 Hearing Impairment  
 Visual Impairment  
 Mobility/Orthopedic Impairment  
 Other  
 None

**Citizenship:** (Choose one)  U.S. Citizen  Permanent Resident  Other non-U.S. Citizen

**Check here if you do not wish to provide any or all of the above information (excluding PI/PD name):**

**REQUIRED: Check here if you are currently serving (or have previously served) as a PI, co-PI or PD on any federally funded project**

---

**Ethnicity Definition:**

**Hispanic or Latino.** A person of Mexican, Puerto Rican, Cuban, South or Central American, or other Spanish culture or origin, regardless of race.

**Race Definitions:**

**American Indian or Alaska Native.** A person having origins in any of the original peoples of North and South America (including Central America), and who maintains tribal affiliation or community attachment.

**Asian.** A person having origins in any of the original peoples of the Far East, Southeast Asia, or the Indian subcontinent including, for example, Cambodia, China, India, Japan, Korea, Malaysia, Pakistan, the Philippine Islands, Thailand, and Vietnam.

**Black or African American.** A person having origins in any of the black racial groups of Africa.

**Native Hawaiian or Other Pacific Islander.** A person having origins in any of the original peoples of Hawaii, Guam, Samoa, or other Pacific Islands.

**White.** A person having origins in any of the original peoples of Europe, the Middle East, or North Africa.

---

**WHY THIS INFORMATION IS BEING REQUESTED:**

The Federal Government has a continuing commitment to monitor the operation of its review and award processes to identify and address any inequities based on gender, race, ethnicity, or disability of its proposed PIs/PDs. To gather information needed for this important task, the proposer should submit a single copy of this form for each identified PI/PD with each proposal. Submission of the requested information is voluntary and will not affect the organization's eligibility for an award. However, information not submitted will seriously undermine the statistical validity, and therefore the usefulness, of information received from others. Any individual not wishing to submit some or all the information should check the box provided for this purpose. (The exceptions are the PI/PD name and the information about prior Federal support, the last question above.)

Collection of this information is authorized by the NSF Act of 1950, as amended, 42 U.S.C. 1861, et seq. Demographic data allows NSF to gauge whether our programs and other opportunities in science and technology are fairly reaching and benefiting everyone regardless of demographic category; to ensure that those in under-represented groups have the same knowledge of and access to programs and other research and educational opportunities; and to assess involvement of international investigators in work supported by NSF. The information may be disclosed to government contractors, experts, volunteers and researchers to complete assigned work; and to other government agencies in order to coordinate and assess programs. The information may be added to the Reviewer file and used to select potential candidates to serve as peer reviewers or advisory committee members. See Systems of Records, NSF-50, "Principal Investigator/Proposal File and Associated Records", 63 Federal Register 267 (January 5, 1998), and NSF-51, "Reviewer/Proposal File and Associated Records", 63 Federal Register 268 (January 5, 1998).

**02 INFORMATION ABOUT PRINCIPAL INVESTIGATORS/PROJECT DIRECTORS(PI/PD) and  
co-PRINCIPAL INVESTIGATORS/co-PROJECT DIRECTORS**

---

Submit only ONE copy of this form for each PI/PD and co-PI/PD identified on the proposal. The form(s) should be attached to the original proposal as specified in GPG Section II.B. Submission of this information is voluntary and is not a precondition of award. This information will not be disclosed to external peer reviewers. **DO NOT INCLUDE THIS FORM WITH ANY OF THE OTHER COPIES OF YOUR PROPOSAL AS THIS MAY COMPROMISE THE CONFIDENTIALITY OF THE INFORMATION.**

---

**PI/PD Name:** Matthew J Penn

**Gender:**  Male  Female  
**Ethnicity:** (Choose one response)  Hispanic or Latino  Not Hispanic or Latino

**Race:**  
(Select one or more)  
 American Indian or Alaska Native  
 Asian  
 Black or African American  
 Native Hawaiian or Other Pacific Islander  
 White

**Disability Status:**  
(Select one or more)  
 Hearing Impairment  
 Visual Impairment  
 Mobility/Orthopedic Impairment  
 Other  
 None

**Citizenship:** (Choose one)  U.S. Citizen  Permanent Resident  Other non-U.S. Citizen

**Check here if you do not wish to provide any or all of the above information (excluding PI/PD name):**

**REQUIRED: Check here if you are currently serving (or have previously served) as a PI, co-PI or PD on any federally funded project**

---

**Ethnicity Definition:**

**Hispanic or Latino.** A person of Mexican, Puerto Rican, Cuban, South or Central American, or other Spanish culture or origin, regardless of race.

**Race Definitions:**

**American Indian or Alaska Native.** A person having origins in any of the original peoples of North and South America (including Central America), and who maintains tribal affiliation or community attachment.

**Asian.** A person having origins in any of the original peoples of the Far East, Southeast Asia, or the Indian subcontinent including, for example, Cambodia, China, India, Japan, Korea, Malaysia, Pakistan, the Philippine Islands, Thailand, and Vietnam.

**Black or African American.** A person having origins in any of the black racial groups of Africa.

**Native Hawaiian or Other Pacific Islander.** A person having origins in any of the original peoples of Hawaii, Guam, Samoa, or other Pacific Islands.

**White.** A person having origins in any of the original peoples of Europe, the Middle East, or North Africa.

---

**WHY THIS INFORMATION IS BEING REQUESTED:**

The Federal Government has a continuing commitment to monitor the operation of its review and award processes to identify and address any inequities based on gender, race, ethnicity, or disability of its proposed PIs/PDs. To gather information needed for this important task, the proposer should submit a single copy of this form for each identified PI/PD with each proposal. Submission of the requested information is voluntary and will not affect the organization's eligibility for an award. However, information not submitted will seriously undermine the statistical validity, and therefore the usefulness, of information received from others. Any individual not wishing to submit some or all the information should check the box provided for this purpose. (The exceptions are the PI/PD name and the information about prior Federal support, the last question above.)

Collection of this information is authorized by the NSF Act of 1950, as amended, 42 U.S.C. 1861, et seq. Demographic data allows NSF to gauge whether our programs and other opportunities in science and technology are fairly reaching and benefiting everyone regardless of demographic category; to ensure that those in under-represented groups have the same knowledge of and access to programs and other research and educational opportunities; and to assess involvement of international investigators in work supported by NSF. The information may be disclosed to government contractors, experts, volunteers and researchers to complete assigned work; and to other government agencies in order to coordinate and assess programs. The information may be added to the Reviewer file and used to select potential candidates to serve as peer reviewers or advisory committee members. See Systems of Records, NSF-50, "Principal Investigator/Proposal File and Associated Records", 63 Federal Register 267 (January 5, 1998), and NSF-51, "Reviewer/Proposal File and Associated Records", 63 Federal Register 268 (January 5, 1998).

## List of Suggested Reviewers or Reviewers Not To Include (optional)

---

### **SUGGESTED REVIEWERS:**

**Spiro Antiochos, NRL**  
**Tom Bogdan, NOAA**  
**Tim Brown, High Altitude Observatory**  
**James Chen, NRL**  
**George Fisher, UC Berkeley**  
**Len Fisk, University of Michigan**  
**Bernhard Fleck, ESA**  
**Allen Gary, MSFC**  
**Leon Golub, Harvard**  
**Joe Gurman, GSFC**  
**Todd Hoeksema, Stanford**  
**Hugh Hudson, UC Berkeley**  
**James Klimchuk, NRL**  
**Alexander Kosovichev, Stanford**  
**Terry Kucera, GSFC**  
**Jeff Kuhn, University of Hawaii**  
**Bob Lin, UC Berkeley**  
**Dana Longcope, Montana State**  
**Ron Moore, MSFC**  
**Eric Priest, St. Andrew U.**  
**Dave Rust, APL, Johns Hopkins U.**  
**Robert Rutten, Utrecht**  
**Alex Pevtsov, NSO**  
**Neil Sheeley, NRL**  
**Phil Scherrer, Stanford**  
**Steve Tomczyk, High Altitude Observatory**  
**Oskar van der Luhe, Kiepenheuer**  
**S.T. Wu, University of Alabama**

### **REVIEWERS NOT TO INCLUDE:**

---



## CERTIFICATION PAGE

### Certification for Authorized Organizational Representative or Individual Applicant:

By signing and submitting this proposal, the Authorized Organizational Representative or Individual Applicant is: (1) certifying that statements made herein are true and complete to the best of his/her knowledge; and (2) agreeing to accept the obligation to comply with NSF award terms and conditions if an award is made as a result of this application. Further, the applicant is hereby providing certifications regarding debarment and suspension, drug-free workplace, and lobbying activities (see below), nondiscrimination, and flood hazard insurance (when applicable) as set forth in the NSF Proposal & Award Policies & Procedures Guide, Part I: the Grant Proposal Guide (GPG) (NSF 09-1). Willful provision of false information in this application and its supporting documents or in reports required under an ensuing award is a criminal offense (U. S. Code, Title 18, Section 1001).

#### Conflict of Interest Certification

In addition, if the applicant institution employs more than fifty persons, by electronically signing the NSF Proposal Cover Sheet, the Authorized Organizational Representative of the applicant institution is certifying that the institution has implemented a written and enforced conflict of interest policy that is consistent with the provisions of the NSF Proposal & Award Policies & Procedures Guide, Part II, Award & Administration Guide (AAG) Chapter IV.A; that to the best of his/her knowledge, all financial disclosures required by that conflict of interest policy have been made; and that all identified conflicts of interest will have been satisfactorily managed, reduced or eliminated prior to the institution's expenditure of any funds under the award, in accordance with the institution's conflict of interest policy. Conflicts which cannot be satisfactorily managed, reduced or eliminated must be disclosed to NSF.

#### Drug Free Work Place Certification

By electronically signing the NSF Proposal Cover Sheet, the Authorized Organizational Representative or Individual Applicant is providing the Drug Free Work Place Certification contained in Exhibit II-3 of the Grant Proposal Guide.

#### Debarment and Suspension Certification

(If answer "yes", please provide explanation.)

Is the organization or its principals presently debarred, suspended, proposed for debarment, declared ineligible, or voluntarily excluded from covered transactions by any Federal department or agency?

Yes

No

By electronically signing the NSF Proposal Cover Sheet, the Authorized Organizational Representative or Individual Applicant is providing the Debarment and Suspension Certification contained in Exhibit II-4 of the Grant Proposal Guide.

#### Certification Regarding Lobbying

The following certification is required for an award of a Federal contract, grant, or cooperative agreement exceeding \$100,000 and for an award of a Federal loan or a commitment providing for the United States to insure or guarantee a loan exceeding \$150,000.

#### Certification for Contracts, Grants, Loans and Cooperative Agreements

The undersigned certifies, to the best of his or her knowledge and belief, that:

- (1) No federal appropriated funds have been paid or will be paid, by or on behalf of the undersigned, to any person for influencing or attempting to influence an officer or employee of any agency, a Member of Congress, an officer or employee of Congress, or an employee of a Member of Congress in connection with the awarding of any federal contract, the making of any Federal grant, the making of any Federal loan, the entering into of any cooperative agreement, and the extension, continuation, renewal, amendment, or modification of any Federal contract, grant, loan, or cooperative agreement.
- (2) If any funds other than Federal appropriated funds have been paid or will be paid to any person for influencing or attempting to influence an officer or employee of any agency, a Member of Congress, an officer or employee of Congress, or an employee of a Member of Congress in connection with this Federal contract, grant, loan, or cooperative agreement, the undersigned shall complete and submit Standard Form-LLL, "Disclosure of Lobbying Activities," in accordance with its instructions.
- (3) The undersigned shall require that the language of this certification be included in the award documents for all subawards at all tiers including subcontracts, subgrants, and contracts under grants, loans, and cooperative agreements and that all subrecipients shall certify and disclose accordingly.

This certification is a material representation of fact upon which reliance was placed when this transaction was made or entered into. Submission of this certification is a prerequisite for making or entering into this transaction imposed by section 1352, Title 31, U.S. Code. Any person who fails to file the required certification shall be subject to a civil penalty of not less than \$10,000 and not more than \$100,000 for each such failure.

#### Certification Regarding Nondiscrimination

By electronically signing the NSF Proposal Cover Sheet, the Authorized Organizational Representative is providing the Certification Regarding Nondiscrimination contained in Exhibit II-6 of the Grant Proposal Guide.

#### Certification Regarding Flood Hazard Insurance

Two sections of the National Flood Insurance Act of 1968 (42 USC §4012a and §4106) bar Federal agencies from giving financial assistance for acquisition or construction purposes in any area identified by the Federal Emergency Management Agency (FEMA) as having special flood hazards unless the:

- (1) community in which that area is located participates in the national flood insurance program; and
- (2) building (and any related equipment) is covered by adequate flood insurance.

By electronically signing the NSF Proposal Cover Sheet, the Authorized Organizational Representative or Individual Applicant located in FEMA-designated special flood hazard areas is certifying that adequate flood insurance has been or will be obtained in the following situations:

- (1) for NSF grants for the construction of a building or facility, regardless of the dollar amount of the grant; and
- (2) for other NSF Grants when more than \$25,000 has been budgeted in the proposal for repair, alteration or improvement (construction) of a building or facility.

AUTHORIZED ORGANIZATIONAL REPRESENTATIVE	SIGNATURE	DATE
NAME <b>Maxine Kahn</b>	<b>Electronic Signature</b>	<b>Jan 22 2009 4:01PM</b>
TELEPHONE NUMBER <b>973-596-3428</b>	ELECTRONIC MAIL ADDRESS <b>srard@njit.edu</b>	FAX NUMBER <b>973-596-6056</b>

\* EAGER - EARly-concept Grants for Exploratory Research

\*\* RAPID - Grants for Rapid Response Research



## Project Summary

Early in 2009 at Big Bear Solar Observatory (BBSO), first light engineering observations of the Sun were made with our 1.6 m clear aperture, off-axis telescope - the NST (New Solar Telescope). The NST will be the most capable, largest aperture solar telescope in the US until the 4 m off-axis ATST (Advanced Technology Solar Telescope) comes on-line in the middle of the next decade. Here we propose, in collaboration with Matt Penn of the National Solar Observatory (NSO) and Thomas Ayres of the University of Colorado (CU), to develop the Cryogenic InfraRed Spectrograph (CIRS) spanning 1.0 to 5.0  $\mu\text{m}$  for the NST. This system is essential for the NST to achieve its scientific potential of probing for the first time the fundamentals of the Sun's atmosphere with its dynamic magnetic field, the origin of space weather, while providing valuable experience and risk reduction for the ATST project. CIRS will be a substantial improvement over the two current solar IR spectrographs – one operating at the National Solar Observatory (on the McMath-Pierce telescope) and the other at Institute for Astronomy (Mees Solar Observatory, University of Hawaii), both of which are based on warm optics except for the detectors and order sorting filters. CIRS will be a significant advance, particularly for high-spatial and high-cadence and high Zeeman sensitivity observations of the Sun's atmosphere from the photosphere through the chromosphere, as well as observations of dimmer targets such as sunspot umbrae and off-limb features.

CIRS will be located on the NST at Big Bear Solar Observatory on Big Bear Lake in the San Bernardino mountains of California. CIRS is a complex cryostat. Construction of the dewar and the incorporated camera system will be handled by an outside vendor specializing in cryogenic instrumentation. BBSO personnel will be responsible for initial design and specification of the dewar and construction of the optical interfaces outside the dewar. These will include image stabilization hardware (correlation tracker), image control and positioning systems (image rotator and scanner), and overall opto-mechanical interfaces that interrupt the Coudé light path and feed light to CIRS. BBSO will perform the final integration of CIRS and will develop the control systems and data acquisition hardware and software.

Spectral observations of the photosphere and chromosphere utilizing the largely unexplored near-infrared (NIR) are crucial for solving many long-standing problems in solar astronomy, especially the disparity among of magnetic field measurements in visible and infrared spectral lines and the origin of the solar chromosphere. The infrared spectrum beyond 1  $\mu\text{m}$  is not only fertile ground for photospheric magnetic diagnostics, but also allows a unique window into the chromosphere lying atop the photosphere. The transition region between the near-equilibrium photosphere and solar corona is complex: the chromosphere is at once host to the coldest material in the whole solar atmosphere ( $T \sim 3500$  K, as seen in off-limb emissions of 4.6  $\mu\text{m}$  the carbon monoxide, CO, lines), and very hot gas ( $T \sim 10^4$  K, associated with ionizing shocks).

High spatial resolution polarimetry at NIR wavelengths requires large aperture telescopes. Here, we propose for funding to develop CIRS for the NST for observations at the Gregorian focal plane.

In sum, we directly address the two criteria required in an NSF proposal:

(1) Intellectual merit: CIRS will be the only fully cryogenic IR solar spectrograph, which will enable the NST to provide the community unique data on the solar magnetic field illuminating the fundamental character of our dynamic star, while probing the origins of space weather. Over the next decade, NSO will build and begin operating the ATST, the flagship telescope for the solar community. CIRS will be a significant testbed for the more complicated IR spectrograph(s) planned for the ATST. After the ATST is on-line, the NST will continue to be an essential telescope in making campaign-style observations.

(2) Broader Impact: The development of the proposed CIRS system continues our decade long tradition of training the next generation of scientists who build instruments. The resulting data will be used in many PhD theses. Our data will be open to the scientific community, and a substantial portion of observing time on the NST will be open to the community.

## TABLE OF CONTENTS

---

For font size and page formatting specifications, see GPG section II.C.

	<b>Total No. of Pages</b>	<b>Page No.* (Optional)*</b>
Cover Sheet for Proposal to the National Science Foundation		
Project Summary (not to exceed 1 page)	1	_____
Table of Contents	1	_____
Project Description (Including Results from Prior NSF Support) (not to exceed 15 pages) <b>(Exceed only if allowed by a specific program announcement/solicitation or if approved in advance by the appropriate NSF Assistant Director or designee)</b>	15	_____
References Cited	1	_____
Biographical Sketches (Not to exceed 2 pages each)	10	_____
Budget (Plus up to 3 pages of budget justification)	6	_____
Current and Pending Support	9	_____
Facilities, Equipment and Other Resources	0	_____
Special Information/Supplementary Documentation	11	_____
Appendix (List below. ) <b>(Include only if allowed by a specific program announcement/ solicitation or if approved in advance by the appropriate NSF Assistant Director or designee)</b>	_____	_____
Appendix Items:		

\*Proposers may select any numbering mechanism for the proposal. The entire proposal however, must be paginated. Complete both columns only if the proposal is numbered consecutively.

---

## A. Project Description

### A.1 Research Activities

#### A.1.1 Overview

Spectral observations of the photosphere and chromosphere utilizing the largely unexplored Near-InfraRed (NIR) are crucial for solving many outstanding problems in solar astronomy, especially the disparity among of magnetic field measurements in visible and infrared spectral lines and the origin of the solar chromosphere. In particular, high spatial resolution polarimetry at NIR wavelengths is essential and requires large aperture telescopes. Here, we propose for funding to implement the Cryogenic InfraRed Spectrograph (CIRS) operating from 1 to 5  $\mu\text{m}$  for the New Solar Telescope (NST) for observations at the Gregorian focal plane. First light engineering observations were made in January 2009 at Big Bear Solar Observatory (BBSO) with the new 1.6 m clear aperture, off-axis telescope - the NST. The NST development was largely funded by an NSF MRI grant (ATM-0320540), which began somewhat more than five years ago. The NST is just beginning its commissioning phase, and its development is described in some detail in Section A.2.1 since its light will feed CIRS. The NST will be the largest aperture solar telescope in the US, and perhaps the world, until the 4 m off-axis ATST (Advanced Technology Solar Telescope) comes on-line in the middle of the next decade. In addition to its tremendous scientific potential, the NST will be the testbed for many essential components and technologies of the ATST including CIRS. *Primarily we propose here, in collaboration with Matt Penn of the National Solar Observatory (NSO) and Thomas Ayres of the University of Colorado (CU), to build and utilize the CIRS, which is essential for the NST to reach its scientific potential.*

#### A.1.2 Scientific Motivation: Photospheric and Chromospheric Magnetic Fields

Many fundamental properties of our dynamic star will finally come within our grasp with the tip-tilt corrected IR light feeding CIRS from the Gregorian focus of the NST. IR data acquired at wavelengths beyond 1.5  $\mu\text{m}$  will be invaluable in addressing key problems of solar physics.

#### A.1.2.1. Magnetic Fields in the Photosphere

Observations of weak magnetic fields in the solar photosphere using absorption lines in the visible spectrum suggest that much of the magnetic flux is concentrated in kilo-Gauss magnetic fields existing in the quiet Sun (Tsuneta et al., 2008; Lites et al., 2008), and the observed weak flux may be a result of the low spatial filling-factor that characterize these fields (e.g. Stenflo 1993). However, when measurements of these fields are made with the more sensitive 1565 nm Fe I (Landé g-factor,  $g_{\text{eff}} = 3$ ) absorption line, a different picture emerged. A distribution of weak magnetic field strengths was seen (Rabin, 1992; Lin 1995), which contradicts the observations made at visible wavelengths. It has been suggested that thermal effects in some visible lines combined with their weaker Zeeman splitting have produced erroneous measurements, and that the field strength distribution measured by the infrared lines is more representative of the true solar magnetic fields (Collados, 2005).

New observations using more sensitive spectral probes of the weak solar magnetic field can help to resolve this problem. A set of Fe I and Si I lines are seen in the photosphere in the reference atlas from Wallace and Livingston (2003) between 3695 and 4150 nm. A Si I and an Fe I line near 4060 nm both have  $g_{\text{eff}} = 1.25$ ; this makes them slightly more magnetically sensitive than the 1565 nm Fe I line (an 8% advantage), see Table 1. Alan Clark has observed the intensity spectra of several spectral lines from Si I near 4137 nm, which do not have their transitions listed by Kurucz (Kurucz and Bell, 1995); from intensity spectra he saw these lines showing large Zeeman splitting, suggesting that they are much more sensitive than the 1565 nm line (by more than 50%). Han Uitenbroek lists only two possible transitions for the Si I line at 4142.5 nm, and the line should have  $g_{\text{eff}} = 1.625$  or  $g_{\text{eff}} = 2.25$ . This means that this line is either 40% or 98% more magnetically sensitive (see Table 1) than the 1565 nm line, and will provide a sensitive measurement of weak solar magnetic fields. Within sunspot umbra, currently the most sensitive line known is the Ti 2231 nm line. Some initial work has been done with this line (Ruedi et al., 1998, Penn et al., 2003) and the  $g_{\text{eff}} = 2.5$  value makes this line 18% more sensitive than the Fe I 1565 nm line. This Si I line at 4142.5 nm will provide an even more sensitive probe of sunspot magnetic fields.

Table 1: IR Bands of Interest for CIRS Magnetic Field Measurements.

Region	Species	$\lambda$ [nm]	$g_{\text{eff}}$	Mag Sensitivity $\lambda g_{\text{eff}}$
Photosphere	Fe I	1565	3	4695
	Ti I (spots only)	2231	2.5	5578
	Fe I	4063.7	1.25	5080
	Si I	4142.5	(1.625 or 2.25)	(6732 or 9321)
Chromosphere	Ca I	854.2	1.0	854
	Ca I	3697.4	1.1	4067
	Mg I	3681.6	1.17	4307

The importance of weak magnetic fields was pointed out in Stenflo (1993): the flux in this weak field component is comparable to the strong-field flux and therefore the role of weak fields in the solar dynamic processes should not be underestimated since the emergence rate is two orders of magnitude larger than that of active regions. Not only will new measurements of this 4142 nm Si I line address weak fields in the solar photosphere, but they also will provide the most accurate photospheric measurements possible needed to address such problems as i) the dynamics of the magnetic field in the photosphere; ii) injection of twist in the solar atmosphere (and related questions of energy build-up); and iii) coronal heating processes.

#### A.1.2.2. Magnetic Fields in the Chromosphere

Recent work measuring the magnetic fields in the solar chromosphere using the 854.2 nm Ca I line have produced intriguing results regarding the magnetic canopy, and also show interesting effects in filament channels (Harvey et al., 2003). A promising chromospheric line in this spectral region is the Mg I line at 3681.6 nm. With a  $g_{\text{eff}} = 1.17$ , this line is 5 times more sensitive to Zeeman splitting than the 854.2 nm line. With the gain in magnetic sensitivity provided at these longer wavelengths, a new realm of sensitive chromospheric magnetic measurements will be possible when these lines are used.

One of the many advantages of chromospheric magnetic field measurements is related to their height of formation. Various force-free extrapolation models assume that the photospheric field (used as a boundary condition) is force-free, which is rather a gross simplification in case of visible magnetograph lines

such as Fe I 630.2 nm. The magnetic field becomes force free only when the plasma  $\beta$  (gas pressure divided by magnetic pressure) is of order  $10^{-1}$ , which occurs in the chromosphere. Thus, observations in IR chromospheric lines will provide measurements consistent with force-free models, which will inevitably improve our ability to model coronal magnetic fields above active regions, and in the heliosphere.

CIRS will be a substantial improvement over the two current solar IR spectrographs – one operating at the National Solar Observatory (on the McMath-Pierce telescope) and the other at Institute for Astronomy (Mees Solar Observatory, University of Hawaii), both of which are based on warm optics except for the detectors and order sorting filters. CIRS will be a significant advance, particularly for high-spatial and high-cadence and high Zeeman sensitivity observations of the Sun’s atmosphere from the photosphere through the chromosphere, as well as observations of dimmer targets such as sunspot umbrae and off-limb features. As one of the planned ATST focal plane instruments, the NIR Spectro-Polarimeter (NIRSP), operating in the 1-5  $\mu\text{m}$  range, will be developed by NSO. This system will be configured at the Gregorian focus (NIRSP-G) and coudé focus (NIRSP-C) to provide coronal spectroscopy and photospheric spectropolarimetry. In addition, the Thermal IR Polarimeter (TIPS) is being considered as one of the downstream, operational phase instruments. TIPS will cover the entire thermal range from 5  $\mu\text{m}$  out to the long wavelength cutoff at about 28  $\mu\text{m}$ . Without a doubt, CIRS will be a significant testbed for these more complicated IR spectrographs planned for the ATST.

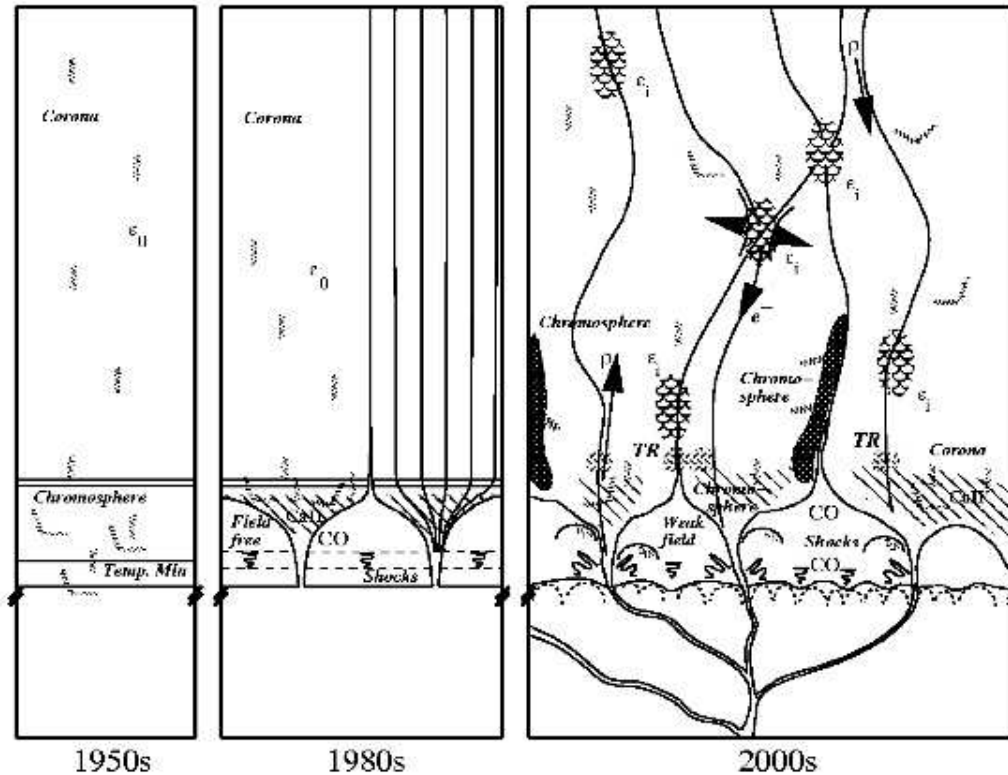

Figure 1: Cartoon of evolution of thinking concerning the solar chromosphere (C. J. Schrijver). It has grown from a simple ‘layer’ of the 1970’s; to topologically more diverse view of the 1980’s, mixing cool (“CO”) and hot gas at similar high altitudes, although still largely static; to contemporary highly dynamic and spatially chaotic “Magnetic Complexity Zone.” This messy region now is speculated to be the main power source of the overlying corona, rather than the historical view in which coronal “tail” to some extent wagged the chromospheric “dog.”

### A.1.2.3. Structure of the Chromospheric in the IR

The infrared spectrum beyond  $1 \mu\text{m}$  not only is fertile ground for photospheric magnetic diagnostics, but also allows a unique window into the chromosphere lying atop of photosphere. The transition region between the near equilibrium photosphere and solar corona is complex: the chromosphere is at once host to the coldest material in the whole solar atmosphere  $T \sim 3500 \text{ K}$ , as seen in off-limb emissions of  $4.6 \mu\text{m}$  the carbon monoxide, CO, lines), and very hot gas ( $T \sim 10^4 \text{ K}$ , associated with ionizing shocks).

Chromospheric models (Ayres and Rabin 1996 and references therein) based on the CO vibration-rotation spectral band show that below a 1000 km, over most of the solar surface, most of the time, there is no chromosphere: most of the volume below the magnetic canopy is occupied by a region that is cooler than the temperature minimum of standard models.

The CO molecular band is a uniquely suitable probe

of the transition from the photosphere to the outer atmosphere, mostly because they strongly dissociate at temperatures in excess of 4000 K. The band lines are formed closely in LTE and they have narrow contribution functions.

The molecular observations to date have made progress in directly imaging the strangeness of the chromosphere, see Figure 1. A major thrust of contemporary solar (and stellar) physics is to dig deeper into this enigmatic chromosphere, in an effort to understand its role in energy transport and atmospheric heating, and as a reservoir of mass and energy to feed the overlying corona (whose heating and mass loading requirements are but a small fraction of those of the chromosphere itself).

The recent advances in IR sensors, spectrographs, optical multiplexing technology (“image slicers”), and adaptive optics, embodied in the proposed CIRS for the NST, will finally enable the full-fledged thermodynamic mapping studies that a number of groups

Table 2: CIRS Initial Scientific Programs.

Senior Personnel in Alphabetical Order	Project
Thomas Ayres	4.6 $\mu\text{m}$ studies of the COmosphere
Wenda Cao	Distribution of B-fields in Quiet Sun
Philip Goode	Relative Properties of Fibril Fields in Photosphere and Chromosphere
Valentyna Abramenko, Vasyl Yurchyshyn and Goode	Flux Emergence and Space Weather
Aleksandra Andic and Goode	Photospheric and Chromospheric Oscillations
Matt Penn	Studies of Photospheric and Chromospheric B-Fields
Graduate Student(s)	Work with Instrument and Science Teams

have been conducting in a prototype way for the past decade (e.g., Uitenbroek, Noyes, & Rabin, 1994; Ayres & Rabin, 1996; Ayres, Plymate, & Keller, 2006). One obtains ‘movies’ of temperature (from CO line depths) and line-of-sight velocity (Doppler shifts) over a patch of the solar surface by repetitively stepping the image across the slit of the spectrometer (or, by means of an image slicer over a smaller field of view). The CO 4.6  $\mu\text{m}$  lines arise at relatively high altitudes, thanks to the preference of the molecular chemistry for cooler temperatures; and their formation very close to LTE, a helpful property of molecular rovibrational lines in general. Visible atomic lines strong enough to arise at high altitudes commonly are affected by NLTE formation, which sharply diminishes their value as thermodynamic tracers.

In addition to probing conditions in the upper photosphere, the CO bands can reach into the low chromosphere by exploiting the fact that they go into “emission” above the solar limb (actually, the line cores are radiating at relatively low temperatures,  $\sim 3500$  K, but the surrounding continuum fades away above the limb, leaving only the optically thick CO to radiate). The physical properties of the COmosphere alluded to previously—especially, how much of the chromospheric volume it occupies—still are largely unknown, and this is mainly due to the relatively primitive state of contemporary IR observations.

The versatile CO lines also are excellent probes of thermodynamic structure in, and around, cool sunspot umbrae; although progress in this area has been hampered again by lack of IR spectroscopic capabilities (not to mention the simple lack of sunspots during the

past few years during the minimum of cycle 23).

Keys to exploiting the CO bands in practice are: (1) high spatial resolution ( $< 1''$ ); (2) high spectral resolution ( $> 100,000$ ); (3) low scattered light (in the off-axis NST optics as well as in the spectrograph); and (4) good sensitivity (for fast scanning). High spatial resolution and good sensitivity imply a large telescope aperture, like that of the NST; and low scattered light implies a modern, off-axis telescope design, again like the NST.

CIRS will be used by BBSO scientists (Goode, Cao, Abramenko, Yurchyshyn and Andic) in collaboration with Ayres and Penn to attack the scientific problems discussed in this section. Some initial topics are listed in Table 2.

## A.2 Description of Research Instrumentation and Needs

### A.2.1 Schematic of the NST

BBSO has removed its old 0.6 m aperture telescope (donated to the Los Angeles Amateur Astronomy Society) and the alignment of the modern, off-axis 1.6 m clear aperture instrument (Goode et al., 2003) has been finished and first engineering light has been attained at the Nasmyth focus. CIRS will have a slightly different light feed. The telescope has been run for several days tracking the Sun with full sunlight on the heat stop and images of granulation obtained at the Nasmyth under winter seeing conditions. The new telescope offers a significant improvement in ground-based high angular resolution capabilities, and will substantially enhance our efforts to understand as-

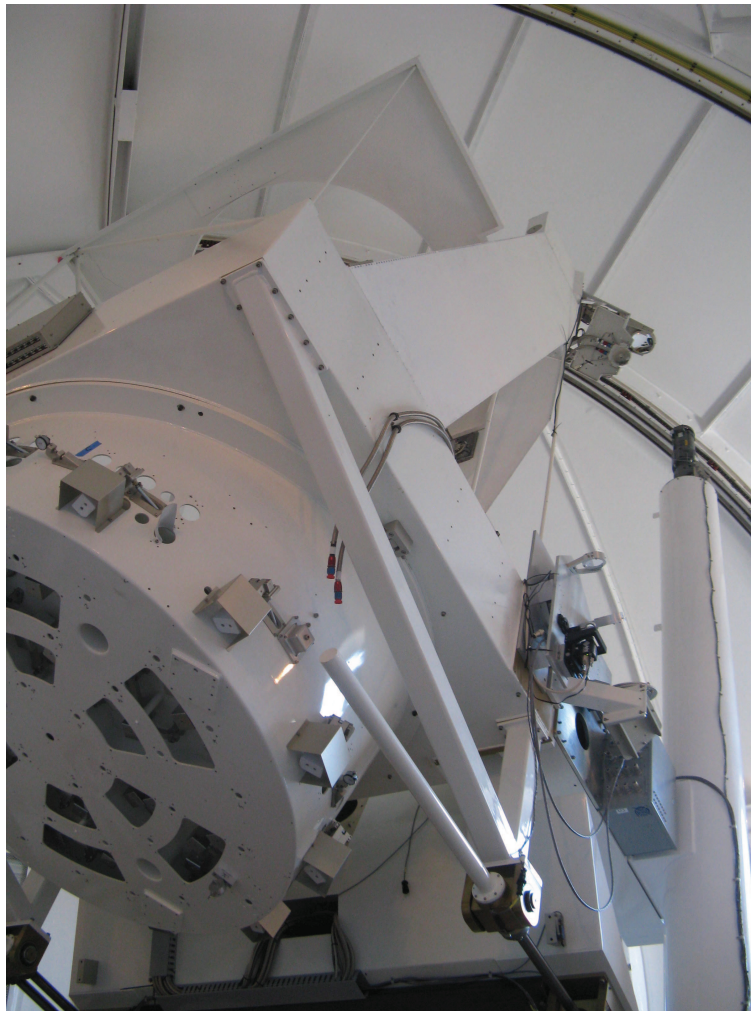

Figure 2: The NST mirror cell (lower left), secondary mirror on hexapod (upper middle), M3 complex with wavefront sensing system (lower right), one counterweight for right ascension balance (extreme right), and aperture shade (middle top).

pects of the photosphere and chromosphere that are best revealed by NIR spectroscopy, as detailed in Section A.1.2. The NST project is described in detail in <http://www.bbso.njit.edu/newtelescope>.

The NST is configured as an off-axis Gregorian system consisting of a parabolic primary, prime focus field stop and heat reflector (heat-stop), elliptical secondary and diagonal flats, see Figures 2 and 3. The primary mirror (PM) is 1.7 m with a clear aperture of 1.6 m. The PM was figured to a final figure residual error of 16 nm rms by Steward Observatory Mirror Lab. The focal ratio of the PM is  $f/2.4$ , and the final ratio is  $f/50$ . The  $180''$  circular opening in the field stop defines a  $120'' \times 120''$  maximal square field of view (FOV) of the NST. This field is re-imaged by the secondary forming the Gregorian focus about 5 me-

ters distant. The light is folded through the Declination axis and then either directed by the coudé mirror down the polar axle or allowed to pass on through the Declination axle to the Nasmyth Bench. The working wavelength range will cover 0.4 to  $1.7 \mu\text{m}$  in the Coudé Laboratory two floors beneath the telescope, and all wavelengths including far infrared at the Nasmyth focus on an optical bench attached to the side of the telescope structure. Here we are proposing for a spectrograph at the feed from the Gregorian focal plane along the path to the Coudé Laboratory. NST's off-axis design was chosen principally because of its vastly reduced stray light, since there is no central obscuration, which reduces the telescope's MTF (Modulation Transfer Function) at high spatial frequency.

We have designed an open telescope structure with

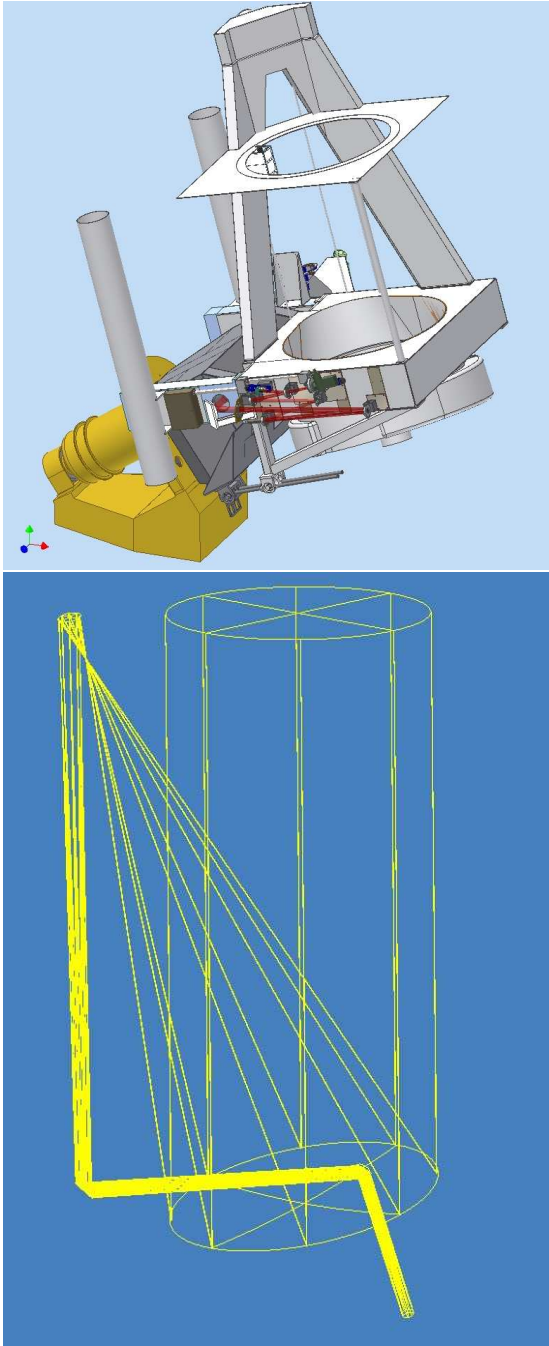

Figure 3: Schematic of the 1.6 m off-axis, open NST (top) and its optical layout (bottom). On the top part, the heat stop (HS) resides at the prime focus with the SM mounted on a PI hexapod. The wavefront sensing system (WFS) resides immediately before M3. M4 is mounted on the telescope fork and sends the light to the Coudé Room below. The HS, SM, M3 and M4 are not apparent in the figure. If M4 is flipped out the light goes to the Nasmyth Bench for which the light path is shown in red. This is where the first light observations occurred. The design was driven by competing needs for rigidity near the SM and an open light path. For more details, see <http://www.bbso.njit.edu/newtelescope>.

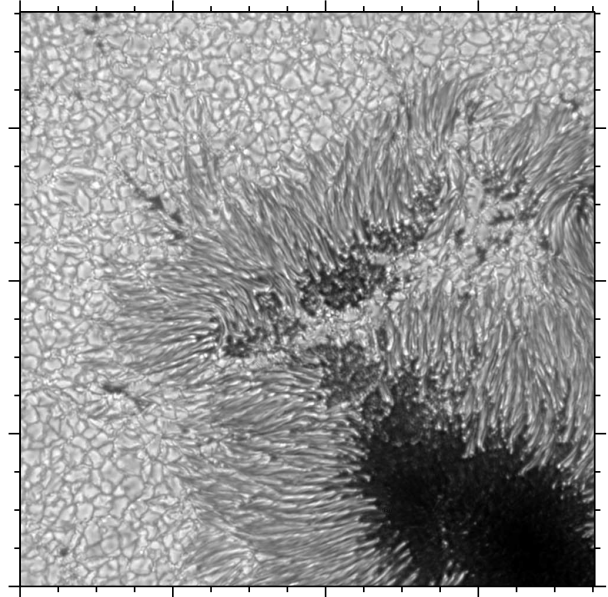

Figure 4: A diffraction-limited image obtained from the old 65 cm BBSO telescope, which serves to demonstrate the quality of the site.

an equatorial mount, as illustrated in Figure 2. A key design issue for a large aperture, solar telescope is the thermal control system to keep the temperature of the mirrors very close to, or even slightly below that of the ambient air. The dome employs a wind-gate and exhaust system to control the airflow from the wind helping to maintain the same temperature inside and outside the dome, and remove concentrations of heat in and around the optical paths. In fact, we have measured the temperatures along the optical path from the telescope to the Coudé Laboratory (which is thermally controlled to 0.5 K). When the vent gates and exhaust system are turned on, the temperature all along the optical path becomes precisely uniform. In addition, we have implemented a closed cycle, chilled air system as part of the OSS (Optical Support Structure) to limit so-called “mirror seeing” by sweeping away turbulent cells and directly cooling the PM. What matters for CIRS is the feed to the Coudé Lab, which also has an isothermal light path. The OSS and active support mirror cell were built and tested by DFM, Engineering in Longmont, CO. The PM is supported by 36 actuators that can bend out low-order aberrations, such as those due to gravity and/or thermal effects. Its shape will be controlled by a wavefront sensing system (<http://www.wavefrontsciences.com>), which resides immediately before M3. First light en-



engineering observations of the Sun have been made at the Nasmyth focus, and granulation is apparent. There is still a few weeks effort before we surpass images from the old telescope, as shown in Figure 4. Still, the commissioning phase of the NST has begun, and scientific observations at the Nasmyth will long precede the beginning of the work proposed here.

The new, larger dome, required to house the NST, is fully operational and the installed telescope is shown in Figure 2. The elliptical secondary mirror (SM) was silvered, and was been tested by both SORL (Space Optics Research, which figured the SM) and Steward before its installation on the NST PI hexapod. The NST telescope control system (BBSO-TCS) has been developed by BBSO staff over the past several years. The TCS supplied by DFM Engineering is used for low level control of the telescope pointing and some on-board systems. The more complex BBSO-TCS is now operational and controls all telescope functions, on-board systems, and the dome. BBSO-TCS orchestrates the M2 hexapod, wavefront sensor, PM actuators, several Galil motion controllers, and the DFM-TCS. In addition, camera controls and data acquisition systems have been developed to obtain images from the Nasmyth Bench. The next step will be to bring the Correlation Tracker (CT) online. This will supply stabilized images to the Nasmyth cameras. This CT technology will be used in the feed optics to CIRS.

### A.2.2 Strehl Ratio of the Beam Feeding the Spectrograph

Ideally, we would like CIRS to be fed with diffraction limited light over the entire 1.0-5.0  $\mu\text{m}$  range of operation. This spectral range does not require full adaptive optics correction because the terrestrial atmosphere is less turbulent in the IR than in the visible, so tip-tilt corrections alone are sufficient for most observations. Given the seeing at BBSO and the limitations of tip-tilt corrections, the diffraction limit will almost never be achieved at 1.0  $\mu\text{m}$ , while for wavelengths beyond 2.5  $\mu\text{m}$ , diffraction limited observations will be the norm.

The Strehl, generally used to quantify the performance of an adaptive optics (AO) system, is the ratio of the maximum intensity in the corrected image in the detector plane to that from a theoretical, perfect imaging system operating at the diffraction limit. Experience, at the NSO at Sacramento Peak (NSO/SP) and

elsewhere, from existing solar AO systems as well as detailed performance modeling of corrected observations using MHD simulations of solar magnetic fields show that a Strehl of  $S \geq 0.3$  is required to perform the desired quantitative analysis of the small-scale magnetic elements. So, under what circumstances will this Strehl be achieved for light fed to our planned spectrograph by a tip-tilt system?

A simple way of quantifying the image quality after tip-tilt correction is by computing the residual wavefront error variance,  $\sigma^2 = 0.134(D/r_0)^{\frac{5}{3}}$ . From this, we can calculate the Strehl of a long exposure image in the usual Marechal approximation (for more detailed discussion see Christou et al., 2006a, and Christou et al., 2006b and references therein), where  $S = e^{-\sigma^2}$ . Further,  $D$  and  $r_0$  are the telescope aperture diameter and  $r_0$  is the Fried parameter. Often, the Fried parameter is used to quantify the seeing conditions at a site.  $r_0$  is the coherence length of the atmospheric turbulence. Without image correction, for telescope apertures larger than  $r_0$ , resolution is seeing limited. The Fried parameter is wavelength dependent ( $r_0 \propto \lambda^{\frac{6}{5}}$  for the generally-assumed Kolmogorov turbulence). The BBSO site has been well-studied within the ATST site survey (see <http://atst.nso.edu/site> for details). Over the two years of seeing measurements, BBSO has been shown to be characterized by steady seeing all day long with an average of Fried parameter of about 6.5 cm for light of  $\lambda = 0.5\mu\text{m}$ . About one-quarter of the time,  $r_0 \geq 10$  cm all day long. The origin for the steady, good seeing is the well-documented lack of ground-level atmospheric turbulence, which is the result of the NST dome being located in the middle of Big Bear Lake. The lake is almost always cooler than the air and, thus, provides a natural inversion that suppresses the turbulence during our typical observing conditions in which a constant wind comes from the west over two miles of open lake water.

Using the Marechal approximation and assuming  $r_0 \sim 10$  cm at  $\lambda = 0.5\mu\text{m}$  in all cases in this paragraph, we calculate that at 1  $\mu\text{m}$   $r_0 \sim 25$  cm, and we have  $S = 0.03$ , which means we are seeing limited with a seeing disk of about  $0''.5$ . At 1.6  $\mu\text{m}$ , where the Sun has its opacity minimum and there are strong magnetic lines, we have  $r_0 \sim 40$  cm and a tip-tilt corrected  $S = 0.26$ , which is close to the 0.3 that experience has taught us is sufficient for diffraction limited imaging that would be  $0''.20$  at 1.6  $\mu\text{m}$  for the spectrograph.

At  $2.5 \mu\text{m}$ ,  $r_0 \sim 70 \text{ cm}$  and  $S \sim 0.7$ . For all wavelengths red of  $2.5 \mu\text{m}$ , even the everyday seeing, after tip-tilt correction, is sufficient to feed diffraction limited light to the spectrograph. In general, we plan to use our real-time speckle reconstruction system as a daily guide to the best wavelengths to observe with the spectrograph. Some particular wavelengths of interest in the  $1\text{-}5 \mu\text{m}$  band are listed in Table 1, along with their significant properties and the science tasks that can be attacked with the spectrograph.

### A.2.3 Zeeman Splitting in the NIR

Another advantage at longer-than-visible wavelengths is the appreciably greater Zeeman splitting, which enables us to separate the true magnetic field strength and filling factor from the magnetic flux that is measured in the visible.

Observations in the NIR benefit from the fact that the Zeeman splitting increases quadratically with wavelength. Observations in that regime are vital for measurements of weak magnetic field strengths. In that way, visible and NIR observations complement each other because the former gives us higher resolution and the latter gives a better separation of magnetic flux into field strength and filling factor.

The Zeeman splitting,  $\delta\lambda$ , is given by  $\delta\lambda \propto g_{\text{eff}}B\lambda^2$ , or more typically the fractional Zeeman splitting  $\delta\lambda/\lambda \propto g_{\text{eff}}B/\lambda = \lambda(g_{\text{eff}}B)$ , where  $\lambda$  is the wavelength,  $g_{\text{eff}}$  is the Landé  $g_{\text{eff}}$ -factor and  $B$  is the magnetic field strength. Further,  $(g_{\text{eff}}B)$  is called the ‘‘Magnetic Sensitivity’’ for purposes of comparing the utility of various IR lines.

### A.2.4 The CIRS Development Plan

The CIRS is a complex cryostat, and construction of the dewar and the incorporated camera system will be handled by an outside vendor (IR Labs) specializing in cryogenic instrumentation. BBSO and CIRS proposal personnel, as well as Don Mickey (designer of the IR solar spectrograph at the University of Hawaii) and IR Labs personnel were responsible for the initial design and specification of the dewar and the optical interfaces outside the dewar. These will include the image stabilization hardware (correlation tracker), image control and positioning systems (image rotator and scanner), and the overall opto-mechanical interfaces that interrupt the Coudé light path and feed light

to CIRS. After funding, this team will make, and then review the final design, and this design will be subsequently reviewed by other outside experts (such as William Livingston and Haosheng Lin). After construction, BBSO will perform the final integration of CIRS and will develop the control systems and data acquisition hardware and software.

Design of the CIRS and its support optics will be finalized and externally reviewed within the first six months of the project. Once the Critical Design Review is completed, the work will be able to proceed in parallel on three fronts:

- 1) IR Labs Inc. of Tucson AZ will be contracted to assist with final design, fabrication and implementation of the dewar, building and installing the various cryo-mechanisms, and providing a turn-key IR camera system with the sensor integrated in the dewar. This is part of the standard instrument development that they offer. The integrated camera system is a unique product that will save a lot of design and development at BBSO, trimming cost and about one year off the project.

- 2) BBSO will proceed with development of the optical path to CIRS and integrate the support structures required into the standard optical path to the Coudé Laboratory. The interface to CIRS will be installed as a place holder during the refurbishing of the Coudé Lab’s Adaptive Optics system. This will allow Coudé Lab observations to proceed with minimal interruption during the installation and ‘static’ testing of CIRS.

- 3) At the same time, BBSO will proceed with CIRS control system development along with the fabrication and testing of the various moving systems requiring machine control in the optical path external to the dewar.

Once these tasks are completed and the dewar system has been delivered, the BBSO team will integrate the external optical bench and dewar, install internal optical elements and proceed with testing of the overall system. The initial work will be done in our on-shore laboratories and all but final testing can be accomplished with a warm dewar. This will minimize the testing required once CIRS is installed at the telescope.

After bench tests in BBSO laboratories are complete and the instrument is certified as operational, CIRS will be transported to the telescope and installed

on the third floor along with its control system and cryo-compressor, as illustrated in Figure 5. This move will require a crane to lift the dewar and bench into position and will likely mean that most of its optics will have to be disassembled for safety and reinstalled at the telescope.

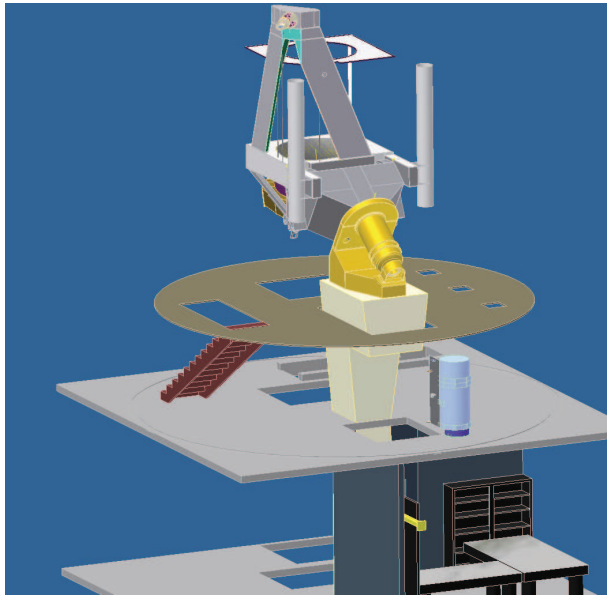

Figure 5: A cutaway sketch of CIRS location with respect to NST and Coudé Lab. The CIRS volume is represented by the blue cylinder and is located on the concrete floor above the Coudé Lab.

### A.2.5 The Opto-Mechanical Design of CIRS

A baseline concept has been developed for CIRS with sufficient detail to confirm good optical performance across the desired wavelength band of 1 to 5  $\mu\text{m}$  and identify feasible locations for the dewar and fore-optics, see Figure 6 and 7. CIRS is configured as an out-of-plane Ebert design using a 79 line/mm grating at an f-number of 2340. The theoretical resolving power of the spectrograph is proportional to the grating width and inversely proportional to the slit width. CIRS will use the widest grating commercially available to meet its resolution criteria. The grating is also a custom length to allow clearance for light paths within the dewar but is readily available from Newport Optics. The slit width is set to 1/2 the Rayleigh criterion to properly sample the NST image. Thus, the resolving power decreases with increasing wavelength (and increasing slit width) resulting in a large

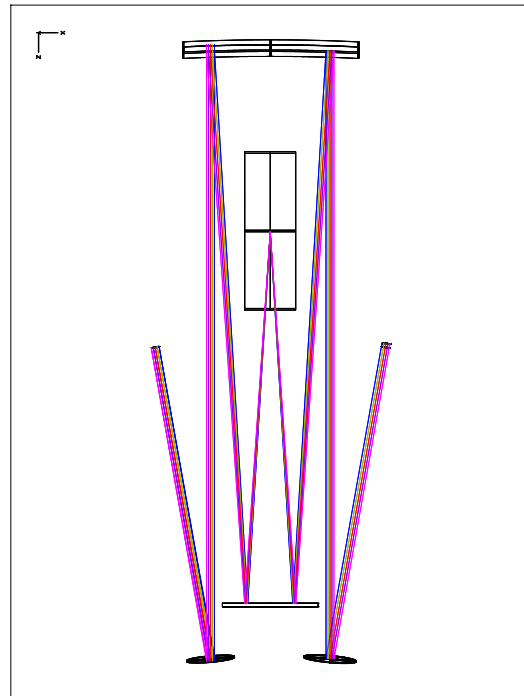

Figure 6: Schematic of the CIRS optical path. The path is symmetric with incoming light, say, on the left and the camera on the right side end of the optical path. In sequence, the light is reflected from a flat mirror, then a collimating mirror, then a flat and into the grating (represented by the rectangle at the center of the figure). The light path is folded twice on either side of the grating to reduce the length of the instrument. The custom size grating allows the light to pass by.

variation over the design bandpass as shown in Figure 8.

Light enters CIRS through a side window in the dewar, is folded to run lengthwise and intercepted by the slit. There will be a series of eight slit-filter combinations housed in a rotating wheel. The image formed at the slit is 100" in diameter and the slit height will be 20 mm. The slit structures and filters will be a standard 25 mm diameter. Each slit will be sized to half the diffraction limit at the wavelength of interest and paired with the appropriate order blocking filter in the wheel. All moving elements within the dewar will be powered by external motors via standard vacuum feedthroughs. There will be no slit viewing camera but context images can be obtained from the Correla-

tion Tracker camera in the fore-optics module.

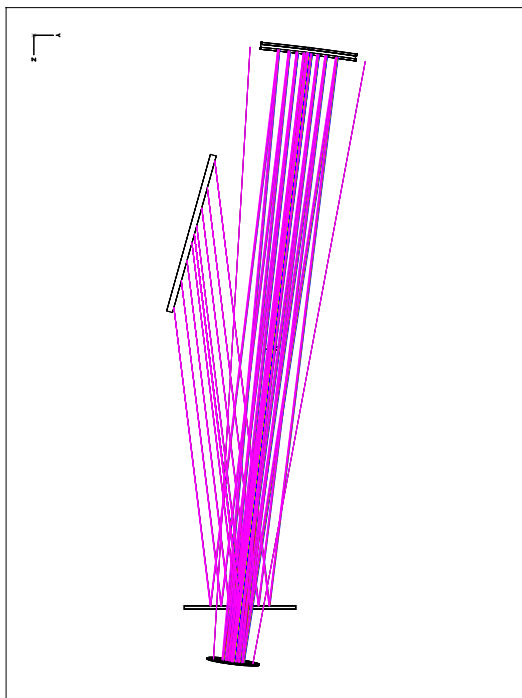

Figure 7: Schematic of CIRS, like Figure 6, but now showing the out-of-plane character of the instrument. The grating (upper left) is located above the slit-collimator-detector plane to allow space for the grating rotation mechanism. The incoming light path is not evident in this view but it lies in the plane between the collimator (at the top of the figure) and the small folding mirror at the bottom.

Beyond the slit the light will be folded back, passing by the slit mechanism to reach the collimator. The collimator is a standard parabola tilted slightly to move the beam out-of-plane and onto the grating. This allows space for the grating rotation mechanism outside the crossing light paths. In the Ebert design, the same parabola is used as the collimator and the focusing element for the detector. This simplifies the spectrograph alignment but presents a challenge for masking the unused portions of the parabola and requires careful attention to scattered light control. The more general Czerny-Turner design which uses two off-axis parabolic elements would also be suitable for the CIRS configuration. The immediate post-funding design work will also examine the trades between these two designs. In either case the light emerg-

ing from the grating is folded again to run lengthwise through the dewar and to shift the beam to the open area opposite the filter wheel where the detector will be mounted on a focus stage. The detector is an InSb 1024x1024 array produced by Raytheon in California. IR Labs produces a standard turn-key system that can operate this array at 30 frames/second. The camera will be integrated into the dewar by IR Labs. The optical performance of CIRS is illustrated by the spot diagram in Figure 9. CIRS will be diffraction limited beyond  $2 \mu\text{m}$ .

Light from the 1.6 meter telescope can be directed down the polar axle and transfer optics send the light to the Coudé Lab two floors below the telescope. The CIRS all-reflecting, fore-optics will intercept the light as it exits the polar axle and redirect it to the spectrograph. Since the Gregorian focus occurs inside the axle, a set of transfer optics ( a pair of parabolic mirrors ) will be required to place the image in range of the correlation tracker (CT) subsystem. These transfer optics will be moved in and out of the light path on a linear motion stage mounted at the back of the telescope pedestal. In the CT subsystem a collimating mirror will form a small pupil image on an active mirror that corrects tilt in the incoming wavefront. The system uses a high speed camera and computer to measure the incoming wavefront and send drive signals to the mirror stage correcting image motion. This is identical to the system already developed for the NST's Nasmyth focus. The two systems will be able to share the CT camera and active mirror systems, which will reduce development cost because it is already a sunk-cost for the Nasmyth Bench. Beyond the CT system a rotating K-mirror will be used to set the image position at the slit allowing precise angular location of solar features. In addition the K-mirror will cancel the image rotation caused by the coudé feed mirror on the polar axle. At the entrance window of the dewar a pair of folding mirrors on a linear stage will be used to scan the image across the slit so a 2-dimensional region can be observed. The CIRS dewar and its detector will be maintained at 70-50 Kelvin by means of closed cycle cryo-coolers reducing the thermal background emitted by the spectrograph's optical elements. The cryogenic nature of CIRS means a much improved signal-to-noise performance over existing systems, and this improvement increases in significance with altitude as the thermal

background becomes more competitive with the signal. The slit wheel and slit substrate will provide a good cold mask to eliminate most scatter from the warm elements upstream of the dewar. This will be a substantial improvement over current solar IR spectrographs operating at NSO (on McMath-Pierce telescope) and Institute for Astronomy (Mees Solar Observatory, University of Hawaii), which are based on warm optics except for the detectors and order sorting filters. This will be a significant advantage particularly for observations of dimmer targets such as sunspot umbrae and off-limb features.

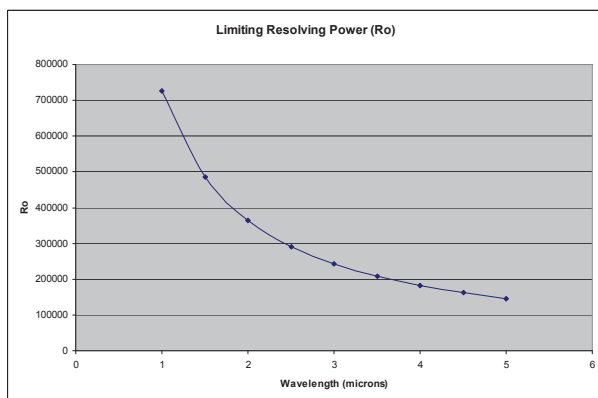

Figure 8: The limiting resolving power of CIRS is plotted v.s. wavelength. Although the actual resolution will be about 2% less than this value, CIRS will meet the design goal for  $R > 100,000$  at  $4.7 \mu\text{m}$ .

### A.2.6 Control Systems

CIRS will have a number of moving sub-systems and will require sophisticated machine control. The NST project has standardized on Galil motion controllers for all ancillary telescope instrumentation and we will continue that mature tradition with CIRS. Each Galil motor controller is capable of running control sequences with onboard firmware. Programming is written in an easy to learn mnemonic language and downloaded to the controller. Standard library functions as well as custom coding can be executed via ethernet. The team is already quite familiar with this control method and can quickly bring the systems on-line. We will use at least two motion controllers, likely having one dedicated to the dewar systems and one the Fore-Optics module.

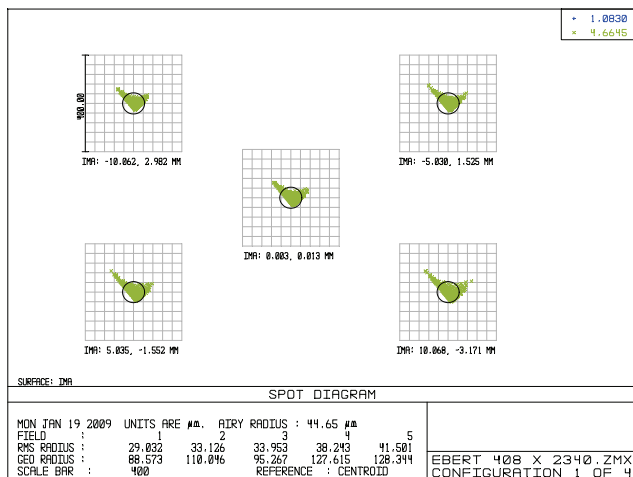

Figure 9: Spot diagram for CIRS for performance at  $1.0$  and  $4.6 \mu\text{m}$ . The green spots show diffraction limited performance at  $4.6 \mu\text{m}$ . The circle represents the Airy disk at  $4.6 \mu\text{m}$ . The blue would show a tiny spot and a tiny Airy radius for  $1.0 \mu\text{m}$ , but the spot is not apparent and the performance would not be quite diffraction limited. However, the performance would be diffraction limited beyond  $2 \mu\text{m}$ .

### A.3 Impact on Research and Training Infrastructure

Designing, building and implementing CIRS on the NST is a unique opportunity for BBSO and the solar community. The CIRS Project will design and implement a unique and valuable instrument on the NST, which is unique by itself. The instrument will enable much significant science and lay the ground work for next generation solar instrumentation, like the ATST and its NIR spectrograph(s). The people participating in the CIRS project are at the vanguard of the new generation of solar astronomy. Even though this project does not directly support a PhD student or postdoctoral associate, they will be involved.

Over the ten years that NJIT has run BBSO, eight former students/postdocs have moved on to tenure track (or tenured) positions at universities or national centers. This includes two women. We carefully mentor our junior people at BBSO. We do this by carefully integrating each into the research and/or instrumentation teams to broaden experience while maximizing intellectual productivity. We have a video conferencing center on site in Big Bear, so we can have joint

seminars and enable classroom teaching from NJIT to BBSO, and vice versa. When ready, postdocs are encouraged to get involved in proposal writing, but great care is taken to keep this effort at a productive level, while not interfering the person's research efforts.

### **A.3.1 Education, Research Training and Mentoring**

NJIT has a diverse student body in an urban environment, with a large minority student population. BBSO highly prizes its special role in the education of the next generation of scientists who build instruments. We currently have six PhD students, including one US citizen, who will receive PhD's from NJIT in various fields: applied physics, electrical and computer engineering, and computer science. The very best NJIT students are attracted to the BBSO program. The typical student designs and builds the instruments used to make his/her PhD measurements in BBSO, although this is not possible for the CIRS Project.

Two PhD student(s) will be involved in this project. However, they will be funded by BBSO's five-year NSF-ATM backbone grant and Cao's NSF Career Award. We believe that this project will be a strong draw for talented NJIT students who are already interested in instrument development. The graduate student will be trained in spectrograph design, and will also assist with the set-up, observation and data analysis. In addition, BBSO typically has 1-2 undergraduates who spend the summer at BBSO, as well as working on BBSO projects during the school year. The NST will also become a teaching tool for optics, mechanics, computer control and solar physics. As well, a postdoctoral associate, Dr. Aleksandra Andic will be involved in the project, by doing image processing and as a user of CIRS. She is supported by other funds.

### **A.3.2 Data and Telescope Time**

Since NJIT began operating BBSO, its telescope time and data have been open to the community. Many scientists have had observing time. Further, several PhD students from around the world have used BBSO data as a central part of their work on their theses. Data requests come to BBSO on a daily basis from around the world. We are an active participant in the Virtual Solar Observatory (VSO). Users of our telescopes and

data are only asked to acknowledge BBSO in their resulting publications. Many observers have used our data to help plan their observing campaigns.

The observing time of the first, next generation solar telescope in the US, the NST, will be oversubscribed because of its much improved scientific capability compared to the old 0.6 m telescope. We will continue our open observing time and open data policies. We plan to make a portion of observing time available to the community. The Telescope Allocation Committee will rank the proposals and allocate time.

## **A.4 Management Plan**

Roy Coulter is the key co-PI on the CIRS Project. He has a quarter-century experience in all aspects of hardware design, development, implementation and testing for solar observatories. He is the Director of the NST project and has designed the CIRS spectrograph. Before his successful effort on the NST, he was the Project Engineer for the off-axis SOLAR-C telescope at the University of Hawaii. His experience as Design Engineer for the AEOS Infrared Spectrograph responsible for radiation shields and closed-cycle cryocooler systems is germane to CIRS. PI Goode has overall responsibility for BBSO, and all its instrumentation projects. Goode is also responsible for mentoring and leading scientific staff at BBSO in the CIRS Project, as well as coordinating between instrumental scientists, like Cao, and the CIRS Project. Goode and Coulter will work closely together on the CIRS Project, as they have on the NST. Goode spends half his time at BBSO.

### **A.4.1 Management Plan and Timelines**

During the building of the NST, we have assembled a strong instrumentation team at BBSO. The commissioning phase of the NST has just begun at this writing. As mentioned, if CIRS is funded several members of the NST team will be partly shifted to the CIRS project. The initial part of the implementation of CIRS will, in fact, be part of the commissioning phase since mounting structures need to be integrated with the light feed to the Coudé Lab AO system. Thus, we already have our team in place to do the proposed work and we risk losing essential BBSO staff and our momentum by delaying the start of the CIRS Project.

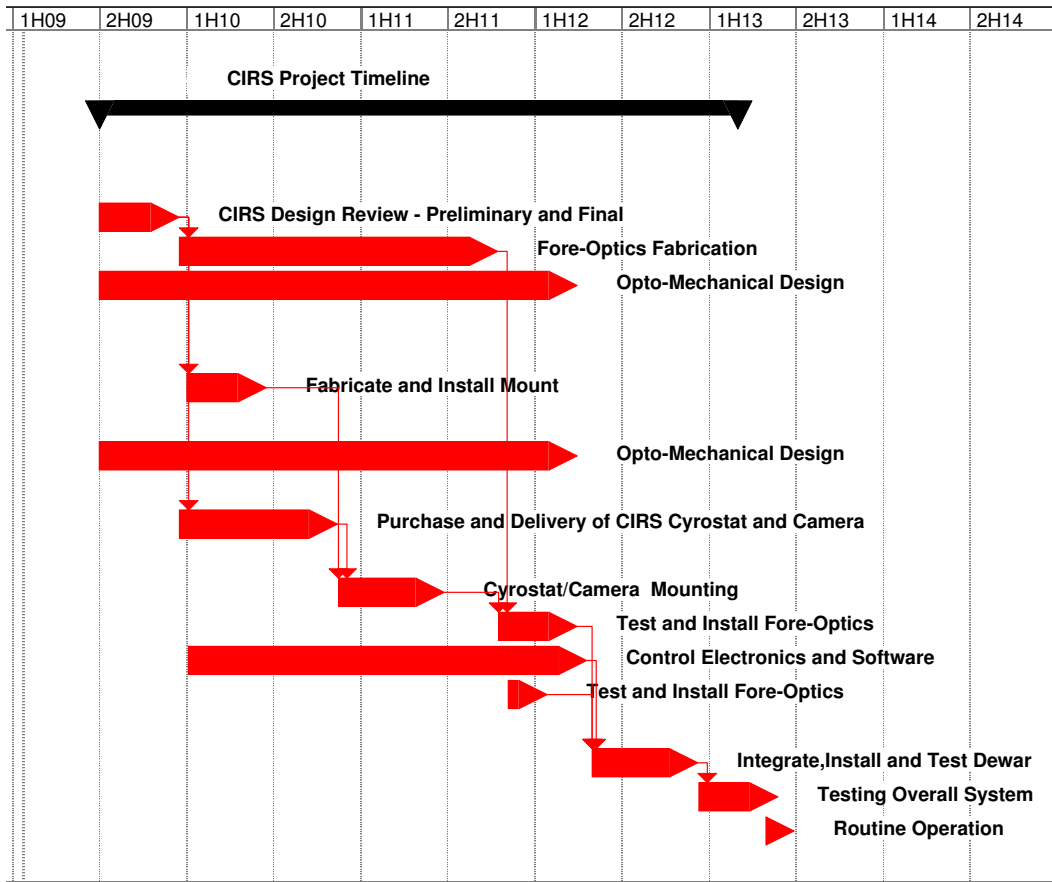

Figure 10: The Gantt Chart shows the CIRS project schedule, which is also detailed in Table 3. The CIRS Project runs for four years beginning mid-year 2009, and chart is divided into half-years.

In the Gantt chart in Figure 10 and in Table 3, we show the major proposed tasks of the CIRS project with timelines, as well as key personnel associated with the tasks. The Gantt chart sketches the CIRS tasks. Before CIRS, visible light and NIR NST observations at the Nasmyth focus will be on-going along with the afore mentioned AO construction. The first year of the CIRS Project will be used to refine designs, conduct the normal internal reviews and confirm those designs with IR Labs. Once the designs are finalized we will establish the construction contract for the dewar. The dewar and hardware for the Fore-Optics mount structure will be purchased during Year 1. In Year 2 the BBSO team will concentrate on producing the Fore-Optics hardware and software while the dewar and camera system are being built at IR Labs. Occasional visits to IR Labs will be used to track progress and stay abreast of any interface issues. Year 3 will see the completion and installation of the Fore-Optics System along with soft-

ware development and operational testing at the telescope. Once the dewar is delivered work will shift to installation of the optics in the dewar, initial alignment and operational testing of the dewar systems and camera controls. During Year 4 the project will culminate with final operational testing and installation at the telescope. Once test images are processed and approved the instrument will be brought online for observational use.

#### A.4.2 Hardware and Personnel Budget

The budget requested from NSF for the CIRS Project is \$1,314 K. The total budget is \$1,877 K, which includes a match of \$563 K from NJIT. As well, NJIT faculty and senior members of the CIRS Team will be working on the CIRS Project with no charge. The contribution here is difficult to know exactly, but it amounts to about 1 FTE. The largest equipment expenditure is \$772 K for the cryostat and 1-5  $\mu\text{m}$  camera (ALADDIN-II, InSb) and the mounting structure

Table 3: Tasks and Assignments for the CIRS Project.

Year	Task	Personnel
Year 1	Overall Management and Coordination	Goode
	Interface with IR Labs	R. Coulter, Gorceix and A. Coulter
	Opto-mechanical Design	R. Coulter, Gorceix and A. Coulter
	Design Review	Team plus IR Labs plus Don Mickey
	Fore-Optics Fabrication	Nenow
	External Fabrication Contracts	A. Coulter
	Install Fore-Optics Mount	A. Coulter, Nenow
Year 2	Overall Management and Coordination	Goode
	Interface with IR Labs	R. Coulter, Gorceix and A. Coulter
	Opto-mechanical Design	R. Coulter, Gorceix and A. Coulter
	Fore-Optics Fabrication	Nenow
	External Fabrication Contracts	A. Coulter
	Control Electronics	Abramenko, A. Coulter, and Shumko
	Control Software	Shumko, A. Coulter, and Abramenko
	Integration and testing Fore-Optics	R. Coulter, Gorceix, A. Coulter, Shumko and Graduate Student
Year 3	Overall Management and Coordination	Goode
	Opto-mechanical Design	R. Coulter, Gorceix and A. Coulter
	Fore-Optics Fabrication	Nenow
	External Fabrication Contracts	A. Coulter
	Control Electronics	Abramenko, A. Coulter, and Shumko
	Control Software	Shumko, A. Coulter, and Abramenko
	Integration and testing of Dewar	R. Coulter, Gorceix, A. Coulter, Shumko and Graduate Student
	Reduction of Test Data	Goode, Cao, Penn, Ayres and Graduate Student
Year 4	Overall Management and Coordination	Goode
	Control Electronics	Abramenko, A. Coulter, and Shumko
	Control Software	Shumko, A. Coulter, and Abramenko
	Integration and testing of Dewar	R. Coulter, Gorceix, A. Coulter, Shumko and Graduate Student
	Installation of Dewar	R. Coulter, Gorceix, A. Coulter, Shumko and Graduate Student
	Testing of Overall System	R. Coulter, Gorceix, A. Coulter, Shumko and Graduate Student
	Routine Operation	Observing Staff

for the system. This expenditure will be made in the first year after the final design review. In the second year, the internal and external optics of the CIRS will be purchased for a total of \$185 K (split \$114 K from the NSF and \$71 K from NJIT). The largest items here include the grating (\$39 K), the collimator (\$44 K), a series of filters and slits (\$65 K) and the remaining items are individually less than \$10 K. In the third year, we will spend a total of \$75 K split between the tip/tilt stage (\$45 K) and Dalsa Camera (\$30 K) for the correlation tracker system. There are no equipment purchases in the fourth and final year of the project.

The remainder of the budget is dominated by per-

sonnel costs of about one FTE per year over the four year project. As well, NJIT will match with about three-quarters of an FTE per year. Over the length of the project, NJIT will match with two months per year of co-PI Roy Coulter's time and thirteen months (over the project) of Nicolas Gorceix's time. Coulter will manage and coordinate the diverse elements of the project and oversee the optical and mechanical design and operation of the system. Nicolas Gorceix, the BBSO optical engineer, will complete the CIRS optical design, identify vendors, oversee purchasing and assist with integration and testing. Coulter and Gorceix have already made the strawman de-



sign of CIRS. Prof. Wenda Cao is an expert in instrumentation and spectrographs, in particular. Cao will work closely with Coulter and Gorceix. As well, Matt Penn, Thomas Ayres and Phil Goode charge no time to the project, but will work to ensure the success of the CIRS Project. Penn leads the IR instrumentation efforts at the McMath-Pierce telescope and Ayres is an expert in both the NIR and spectroscopic efforts to explore that spectral regime. They will be critical in ensuring optimal possible specifications are identified and met are met by CIRS. Goode has overall responsibility for BBSO and will coordinate efforts among the commissioning efforts of the NST, including CIRS. Cao and Goode will be responsible for the PhD students who will work, in part on CIRS, and be supported by BBSO's current five-year "backbone" NSF grant that is in its first year and Cao's five year NSF Career Award that is just beginning. The effort of these personnel will be focussed on all aspects of implementing the CIRS system. co-PI Roy Coulter will oversee training of observing staff and production of documentation, maintenance, and user manuals.

We request funds to support 3.5 FTE's of engineers over the length of the four year CIRS project. This includes six months of time of BBSO's electronic engineer, Vlad Abramenko, will design and build the electronic interfaces and control hardware; and ten months of time of Sergey Shumko to handle all high level software included interfacing CIRS to the NST Telescope Control System and participate in integration, testing and initial operations of CIRS; and ten months of mechanical engineer Jeff Nenow's time to be responsible for on-site fabrication and assist with assembly; and finally sixteen months of mechanical engineer Aaron Coulter's time to be responsible for mechanical design, outside fabrication contracts, machine control, along with integration and testing.

The travel budget is primarily for collaborating personnel travel between BBSO, NSO/T and CU.

The team is lean, but has already demonstrated its prowess on the the NST project.

## B References

- Ayres, T. R., Plymate, C. and Keller, C. U., 2006, *Solar Carbon Monoxide, Thermal Profiling and the Abundances of C, O and Their Isotopes*, ApJS, 165, 618
- Ayres, T. R. and Rabin, D., 1996, *Observations of Solar Carbon Monoxide with an Imaging Infrared Spectrograph*, ApJ, 460, 1042
- Christou, J. C., Gladysz, S., Redfern, M., Bradford, L. W., and Roberts, L.C., 2006a, in AMOS proceedings
- Christou, J. C., Mighell, K. J., and Makidon, R. B., 2006b, *Strehl Ratio and Image Sharpness for Adaptive Optics*, SPIE, 6272, 59
- Collados, M., 2005, *Quiet Sun Magnetism*, in Solar Polarization IV Workshop, Boulder CO, p.19
- Goode, P. R., Denker, C. J., Didkovsky, L. I., Kuhn, J. R. and Wang, H., 2003, *1.6 M Solar Telescope in Big Bear – The NST*, JKAS, 36, 125
- Harvey, J. W. et al., 2003, AGU meeting #SH42B-0545
- Kurucz, R. L, Bell, B., 1995, *Atomic Line Data*, Kurucz CD-ROM No. 23. Cambridge, Mass.: SAO
- Lin, H., 1995, *On the Distribution of the Solar Magnetic Fields*, ApJ, 446, 421
- Lites, B. W., Kubo, M., Soca-Navarro, H. and 11 co-authors, 2008, *The Horizontal Magnetic Flux of the Quiet-Sun Internetwork as Observed with the Hinde Spectro-Polarimeter*, ApJ, 672, 123
- Madec, P. Y., 1999, in *Adaptive Optics for Astronomy*, F. Roddier ed., Cambridge University Press, p.131
- Penn, M. J., Cao, W. D., Walton, S. R., Chapman, G. A. and Livingston, W., 2003, *Imaging Spectropolarimetry of Ti I 2231 nm in a Sunspot*, Sol. Phys., 215, 87
- Rabin, D., 1992, *A true-field magnetogram in a solar plage region*, ApJ, 390, L103
- Rüedi, I., Solanki, S. K., Keller, C. U., and Frutiger, C., 1998, *Infrared lines as probes of solar magnetic features. XIV. Ti I and the cool components of sunspots*, A&A 338, 1089
- Stenflo, J. O., 1993, *Strong and Weak Magnetic Fields: Nature of the Small-Scale Flux Elements*, in IAU Colloq. 141, eds. Zirin, Ai and Wang, p.205
- Sturrock, P. A., 1989, Proceedings of Max'91 Workshop, p. 1
- Tsuneta, S., Ichimoto, K., Katsukawa, Y. and 11 co-authors, 2008, *The Magnetic Landscape of the Sun's Polar Region*, ApJ, 688, 1374
- Uitenbroek, H., Noyes, R. W. and Rabin, D., 1994, *Imaging Spectroscopy of Solar CO Lines at 4.67  $\mu\text{m}$* , ApJ, 432, L67
- Wallace, L. and Livingston, W., 2003, *NSO Technical Report #03-001*

## CURRICULUM VITAE

### PHILIP R. GOODE

#### Address:

Department of Physics  
New Jersey Institute of Tech. (NJIT)  
Newark, New Jersey 07102

Big Bear Solar Observatory (BBSO)  
Big Bear City, California 92314

#### Phone and E-mail:

Work:(973)596-3565  
Home:(908)232-7907  
pgoode@bbso.njit.edu

Work:(909)866-5791 x20  
Home: (909)-866-0078

#### Education:

Ph.D. (Physics), February 1969  
Rutgers, The State University

A.B. (Physics), June 1964  
University of California, Berkeley

#### Present Positions:

1997- Director, Big Bear Solar Observatory, NJIT  
Director, Center for Solar-Terrestrial Research, NJIT  
1994- Distinguished Professor, Physics, NJIT

#### Thesis Advisor and Postdoctoral Advisors:

Larry Zamick, Daniel Koltun and J.B. French (deceased)

#### Recent Non-BBSO Collaborators

Carsten Denker, Leonid Didkovsky, Wojtek Dziembowski, Peter Gallagher, Stuart Jefferies, Haosheng Lin, Sara Martin, Alexei Pevtsov, Thomas Rimmele, Jesper Schou, Alexandra Tritschler, Harold Zirin

#### Ph.D. Students and Former Postdocs:

Wenda Cao, Jongchul Chae, Carsten Denker, Leonid Didkovsky, Peter Gallagher, Haisheng Ji, Yun Chun Jiang, Klaus Hartkorn, Scott Kleinman, Chang Liu, Pilar Montanes-Rodriguez, Yong-Jae Moon, Enric Palle-Bago, Jiong Qiu, Deqing Ren, Sergio Restaino, Thomas Rimmele, Thomas Spirock, Michael Steininger, Lou Strous, Alexandra Tritschler, John Varsik, Martin Woodard, Guo Yang, Vasyl Yurchyshyn

#### Research Interests:

Sun's interior and atmosphere; magnetic fields; climate change

*Synergistic Activities – Breadth of Activities:*

Director of BBSO. Long experience in studies of magnetic fields, especially in combining ground-based data with satellite data to determine dynamic properties of the solar magnetic fields and space weather.

BBSO has strong instrumentation programs including building the NST, a 1.6 m clear aperture off-axis telescope,. Downstream instrumentation built and tested in BBSO include visible light and near infrared polarimeters, and high-order adaptive optics.

Twelve former students and/or postdocs have moved on to faculty/national center tenure track positions.

*Synergistic Activities - Recent Committees:*

1999: NSF-AST Committee of Visitors  
1999-2000: Solar Panel, Astronomy and Astrophysics Decadal Survey  
2001-2002: Solar and Space Sciences Survey Committee  
2001: Augustine Panel (Blue Ribbon Panel)  
2001: NSF-AST: NOAO Management Recompetition Panel  
2001: NSF-ATM: HAO Review  
2003: NASA: Senior Review  
2005-2008: AAS: Joseph Weber Award for Astronomical Instrumentation Committee  
2005: NASA: Senior Review  
2007: NASA SMEX Panel

**SIX RECENT PUBLICATIONS**

Shortwave Forcing of the Earth's Climate: Modern and Historical Variations in the Sun's Irradiance and the Earth's Reflectance, P.R. Goode and E. Palle, 2007, Journal of Atmospheric and Solar-Terrestrial Physics, 2007, v. 69, iss. 13, 1556.

First Light of the Near-Infrared Narrow-Band Tunable Birefringent Filter at Big Bear Solar Observatory, Cao, W., Hartkorn, K., Ma, J. Xu, Y., Spirock, T., Wang, H., and Goode, P. R., 2006, Solar Physics, 238, 207.

Diffraction-limited Polarimetry from the Infrared Magnetograph at Big Bear Solar Observatory, Cao, W., Jing, J., Ma, J., Xu, Y., Wang, H. and Goode, P.R., 2006, PASP 118, 838.

High-Spatial-Resolution Imaging Combining High-Order Adaptive Optics, Frame Selection, and Speckle Masking Reconstruction, Denker, C., Mascarinas, D., Xu, Y., Cao, W., Yang, G., Wang, H., Goode, P. R., and Rimmele, T., 2005, Solar Physics, 227, 217.

Traces of the Dynamic Current Sheet during a Solar Flare, Ji, H., Wang, H., Goode, P. R., Jiang, Y., and Yurchyshyn, V., 2004, ApJLett, 607, L55.

Rapid Penumbra Decay following Three X-Class Solar Flares, Wang, H., Liu, C., Qiu, J., Deng, N., Goode, P. R., and Denker, C., 2004, ApJLett, 601, L195.

---

## BIOGRAPHICAL SKETCH: Thomas R. Ayres

---

Position: Fellow, CASA; Research Professor, Astrophysical & Planetary Sciences

Center for Astrophysics and Space Astronomy  
University of Colorado at Boulder  
389 UCB, Boulder, Colorado 80309-0389, USA

Email: Thomas.Ayres@Colorado.edu

Research Interests: SOLAR/STELLAR PHYSICS, SPACE ASTRONOMY

Synopsis: Thomas Ayres (AB 1971, Harvard College; PhD 1975, University of Colorado) specializes in observations and analysis of IR, UV, and X-ray spectra of the Sun and other late-type stars; numerical modeling of stellar atmospheric structure and radiative transfer; and image processing and visualization techniques. After graduating from the Astrophysics program in the Physics Department at Colorado, he was a CfA postdoctoral fellow in the early years of the Center for Astrophysics (1975–77), before returning to Boulder to take research positions in two of the University's institutes: JILA (1977–80) and LASP (1980–85). In 1985, he was a founding member of the Center for Astrophysics and Space Astronomy; and has served as CASA associate director from 1996–2000, and 2003–present. In 1990, he was appointed a Research Professor in the Astrophysical & Planetary Sciences Department, where he teaches a biennial graduate course in “Stellar Exteriors” (<http://origins.colorado.edu/~ayres/astr5730>). He has participated on a number of Astronomy-related working groups and committees, including as chair of the National Solar Observatory Users Committee (1997–2005), chair of the Multimission Archive at Space Telescope (MAST) Users Group (2001–2004), councilor of the American Astronomical Society (2001–2004), member of the Solar Physics Division governance committee (2004–2006), and a member of the National Science Foundation's AST division “Senior Review” of astronomical facilities (2005–2006). He currently serves as vice-chair of AURA's Solar Observatory Council (2006–present), which oversees the operations of the National Solar Observatory.

Professional Associations: American Astronomical Society; International Astronomical Union; Astronomical Society of the Pacific; American Geophysical Union.

Recent Publications (2006–present: refereed journals, only):

“Chandra's Darkest Bright Star: not so Dark after All?” AJ, 136, 1810 (2008), T.R. Ayres

“Solar Forbidden Oxygen, Revisited,” ApJ, 686, 731 (2008), T.R. Ayres

“The Photospheric Solar Oxygen Project. I. Analysis of Atomic Lines and Influence of Atmospheric Models,” A&A, 488, 1031 (2008), E. Caffau, H. Ludwig, M. Steffen, T. Ayres, P. Bonifacio, R. Cayrel, B. Freytag, B. Plez

“The Deep Lamp Project: An Investigation of the Precision and Accuracy of the Echelle Wavelength Scales of Space Telescope Imaging Spectrograph,” ApJS, 177, 626 (2008), T.R. Ayres

“The Fainting of  $\alpha$  Centauri A, Resolved,” ApJ, 678, L121 (2008), T.R. Ayres, P.G. Judge, S.H. Saar, J.H.M.M. Schmitt

"X-ray and Ultraviolet Spectroscopy of Intermediate Mass, First Crossing Giants," ApJS, 171, 304 (2007), T.R. Ayres, E. Hodges-Kluck, A. Brown

" $\alpha$  TrA Junior," ApJ, 658, L107 (2007), T.R. Ayres, A. Brown, G.M. Harper

"The Coronae of  $\gamma$  Draconis," ApJ, 651, 1126 (2006), T.R. Ayres, A. Brown, G.M. Harper

"Solar Carbon Monoxide, Thermal Profiling, and the Abundances of C, O, and Their Isotopes," ApJS, 165, 618 (2006), T.R. Ayres, C. Plymate, C.U. Keller

"The Remarkable Far-Ultraviolet Spectrum of FK Comae Berenices: King of Spin," ApJ, 644, 464 (2006), T.R. Ayres, G.M. Harper, A. Brown, H. Korhonen, I.V. Ilyin, S. Redfield, B.E. Wood

Synergistic Activities: development of scale model solar systems for undergraduate teaching and public outreach; high school student astronomy research mentoring program; Denver Museum of Nature and Science space exhibit; University of Colorado Heritage Center space exhibit; "Spectra for the People!" E/PO project at CU's Fiske Planetarium.

Major Collaborators within Past Four Years (including PhD advisor, and former PhD students)

Bennett, J. (self-employed science author) PhD student

Brown, A. (CASA, University of Colorado)

Caffau, E. (Paris Observatory [Meudon], France)

DeForest, C. (Southwest Research Institute, Boulder)

Harper, G. (CASA, University of Colorado)

Hassler, D. (Southwest Research Institute, Boulder)

Hodges-Kluck, E. (University of Maryland [grad student]) undergrad research assistant

Judge, P. (High Altitude Observatory)

Keller, C. (University of Utrecht, Netherlands)

Korhonen, H. (ESO, Germany)

Linsky, J. (JILA, University of Colorado) **thesis advisor** (and post-doctoral mentor)

Osten, R. (Space Telescope Science Institute) PhD student

Plymate, C. (National Solar Observatory)

Redfield, S. (Wesleyan University)

Saar, S. (Center for Astrophysics)

Schmitt, J. (University of Hamburg, Germany)

Wood, B. (Naval Research Laboratory)

## CURRICULUM VITAE

### Wenda Cao

#### Address:

Department of Physics  
New Jersey Institute of Technology (NJIT)  
Newark, NJ 07102-1982

Work: (973) 596 - 5301  
Home: (908) 265 - 8404  
Email: [wcao@bbsso.njit.edu](mailto:wcao@bbsso.njit.edu)

#### Education

*Ph.D.*, Astrophysics and Astronomical Instrument, August 2001  
National Astronomical Observatories, Chinese Academy of Sciences, China  
*M.S.*, Solar Radio Physics, August 1992  
Yunnan Astronomical Observatory, Chinese Academy of Sciences, China  
*B.S.*, Physics, July 1989  
University of National Science and Technology, China

#### Positions Held

2007-present	Assistant Professor, New Jersey Institute of Technology, Newark, NJ
2006-2007	Assistant Research Professor, New Jersey Institute of Technology, Newark, NJ
2003-2005	Post-Doctoral Fellow, New Jersey Institute of Technology, Newark, NJ
2002	Visiting Scientist, National Solar Observatory, Tucson, AZ
1998-2002	Associate Astronomer, National Astronomical Observatories, Chinese Academy of Sciences
1995-1998	Assistant Astronomer, Yunnan Astronomical Observatory, Chinese Academy of Sciences

#### Selected Recent Publications

- [1] Cao, W., Jing, J., Ma, J., Xu, Y., Wang, H., Goode, P. R.: *Diffraction-limited Polarimetry from the Infrared Imaging Magnetograph at Big Bear Solar Observatory*, *Publ. Astron. Soc. Pacific* 118, 838, 2007
- [2] Cao, W., Hartkorn, K., Ma, J., Xu, Y., Spirock, T., Wang, H., Goode, P. R.: *First Light of the Near-Infrared Narrow-Band Tunable Birefringent Filter at the Big Bear Solar Observatory*, *Solar Phys.* 238, 207, 2006
- [3] Xu, Y., Cao, W., Liu, C., Yang, G., Jing, J., Denker, C., Emslie, A. G., Wang, H.: *High-Resolution Observations of Multiwavelength Emissions during Two X-Class White-Light Flares*, *Astrophys. J.* 641, 1210, 2006
- [4] Cao, W., Xu, Y., Denkes, C., Wang, H.: *1024×1024 HgCdTe CMOS Camera for Infrared Imaging Magnetograph at the Big Bear Solar Observatory*, *Proc. SPIE* 5881, 245, 2005
- [5] Xu, Y., Cao, W., Ma, J., Hartkorn, K., Jing, J., Denker, C., Wang, H.: *Properties of Small Dark Features Observed in the Pure Near-Infrared and Visible Continua*, *Astrophys. J.* 628, L167, 2005
- [6] Cao, W., Denker, C., Wang, H., Ma, J., Qu, M., Wang, J., Goode, P. R.: *Characteristic Evaluation of a Near-Infrared Fabry-Perot Filter for Infrared Imaging Magnetograph (IRIM)*, *Proc. SPIE* 5171, 307, 2004
- [7] Xu, Y., Cao, W., Liu, C., Yang, G., Qiu, J., Jing, J., Denker, C., Wang, H.: *Near-Infrared Observations at 1.56 microns of the 2003 October 29 X10 White-Light Flare*, *Astrophys. J.* 607, L131, 2004

- [8] Yang, G., Xu, Y., Cao, W., Wang, H., Denker, C., Rimmele, T. R.: *Photospheric Shear Flows along the Magnetic Neutral Line of Active Region 10486 prior to an X10 Flare*, *Astrophys. J.* 617, L151, 2004
- [9] Matt, P. J., Cao, W., Walton, S., Chapman, G. and Livingston, W.: *Ti I 2231 nm Zeeman Splitting in a Sunspot*, *Solar Phys.* 213, 55, 2003
- [10] Matt, P. J., Cao, W., Walton, S., Chapman, G. and Livingston, W.: *Weak Infrared Molecular Lines Reveal Rapid Outflow in Cool Magnetic Sunspot Penumbra Fibrils*, *Astrophys. J.* 590, L119, 2003

## Research Interests

Astronomical Instruments: Fabry-Pérot interferometer, birefringent Lyot filter, infrared and visible detectors, infrared and visible polarimeter, adaptive optics.

Observation and Research: two-dimensional spectroscopy and polarimetry, infrared high resolution observations, temporal evolution of solar active regions, dynamics of small-scale magnetic fields, flares and filament eruptions.

## Collaborators

Allen Gary, William Livingston, Matt Penn, Thomas Rimmele, Steven Tomczyk, Jiong Qiu, Haimin Wang

## Memberships in Professional Societies

Solar Physics Division of the American Astronomical Society

International Astronomical Union

International Society for Optical Engineering

## Research Activities

- Principal Investigator, *Developing High Resolution Infrared Instrumentation to Explore Solar Activity*, sponsored by National Science Foundation
- Co-Principal Investigator, *High Resolution Studies of Solar Activity with New Solar Telescope*, sponsored by National Science Foundation (PI, P. R. Goode)
- Co-Principal Investigator, *Studies of Solar Activity with Coordinated Observations of New Solar Telescope and NASA Solar Physics Mission*, sponsored by NASA (PI, P. R. Goode)
- Key Investigator, *Infrared Imaging Magnetograph at Big Bear Solar Observatory* (PI, P. R. Goode)
- Key Investigator, *Adaptive Optics System for the 1.6 M Solar Telescope in Big Bear* (PI, P. R. Goode)
- Principal Investigator, *Study of the Solar Observational Technology and Method in Infrared*, Sponsored by the National Natural Science Foundation of China
- Principal Investigator, *Astronomical Infrared Detector Laboratory*, Sponsored by the National Large Astronomical Instrument Manufacture Project of China
- Principal Investigator, *Research on Infrared Focal Plane Array Camera for Solar Observation*, Sponsored by the Natural Science Foundation of Yunnan Province
- Co-Principal Investigator, *1 Meter Infrared Solar Telescope*, Sponsored by National Large Project Foundation 973 Plan of China (PI, G. Ai)



## Biographical Sketch

**Roy Coulter**      Big Bear Solar Observatory  
40386 North Shore Lane  
Big Bear City, California 92315  
909 866-5791 ex. 19

### Professional Preparation

Bachelor of Science in Physics, 1983  
University of Idaho

### Appointments

Big Bear Solar Observatory / NJIT  
Big Bear Lake, CA

2004 – present    *NST Project Director*

Institute for Astronomy / Univ. of Hawaii  
Kula, HI

1999 – 2004      *Senior Mechanical Engineer*

National Solar Observatory  
Sunspot, NM

1998 – 1999      *Technical Resource Manager*

1990 – 1998      *Instrument Specialist*

1983 – 1990      *Observer ( Telescope Operations )*

### Selected Publications

R. Coulter, J.R. Kuhn, H. Lin, **Strategies for Prime Focus Instrumentation in Off-Axis Gregorian Systems**, *SPIE Proc. Vol. 4853*, 2003, Ed. S. Keil and A.S. Avakyan

R. Coulter, J.R. Kuhn, T. Rimmele, **Using Scintillation Measurements to Achieve High Spatial Resolution in Photometric Solar Observations**, *Solar Physics, vol. 163*, 1996

R. Coulter, J.R. Kuhn, **RISE/PSPT as an Experiment to Study Active Region Irradiance and Luminosity Evolution**, *A.S.P. Conf. Ser. Vol. 68*, 1993, Ed. K.S. Balasubramanium and G.W. Simon

## **Synergistic Activities**

Over 25 years experience with astronomical instrumentation and observing techniques, particularly those applicable to solar observations. Project engineer for several major instrumentation efforts at the National Solar Observatory and the Institute for Astronomy:

- Project Engineer for SOLAR-C off-axis coronagraph with responsibility for mechanical and optical design, procurement, fabrication, and on-site management.
- Design engineer for the AEOS Infrared Spectrograph responsible for radiation shields and closed-cycle cryo-cooler systems.
- Provided engineering support for the ATST site test installation on Haleakala and mechanical design for the Sky Brightness Monitor component of the ATST site survey instrument set.
- Responsible for development of liquid nitrogen production plant on Haleakala.
- Technical lead for SOLIS Full Disk Patrol and Solar Coronal Imager.
- Project engineer for Precision Solar Photometric Telescope network.
- Participated in several solar eclipse expeditions.
- Provided maintenance and engineered improvements for the Solar Vector Magnetograph and the Mirror Advanced Coronagraph.
- Developed CCD camera system for the One Shot Coronagraph
- Operated all telescope systems at the National Solar Observatory's Sunspot, NM installation.

## **Collaborators and Other Affiliations**

Jeff Kuhn, Institute for Astronomy  
Haosheng Lin, Institute for Astronomy  
Thomas Rimmele, National Solar Observatory  
Carsten Denker, AIP

## BIOGRAPHICAL SKETCH

---

### Matthew J. Penn

#### Professional Preparation

1992        PhD, Astronomy, University of Hawaii, Honolulu, HI  
1988        MS, Astronomy, University of Hawaii, Honolulu, HI  
1986        BS, Astronomy, California Institute of Technology, Pasadena, CA

#### Appointments

2001-present        Associate Astronomer, National Solar Observatory  
2001-2003, 2005-present    Adjunct Faculty, California State University, Northridge  
1998-2001        Assistant Professor, California State University, Northridge  
1995-1998        Jr. Scientist, National Solar Observatory  
1993              Adjunct Faculty, New Mexico State University, Alamogordo  
1992-1995        Research Associate, National Solar Observatory

#### Selected Publications

Penn, M.J. and MacDonald, R.K.D.: 2007, ``*Solar Cycle Changes in Sunspot Umbral Intensity*'' ApJ Letters, 662, L123

Penn, M.J. and Livingston, W.:2006, ``*Temporal Changes in Sunspot Umbral Magnetic Fields and Temperatures*'' ApJ Letters, 649, L45

Penn, M.J., Lin, H., Tomczyk, S., Elmore, D., Judge, P.: 2004, ``*Background Induced Measurement Errors in the Coronal Intensity, Density, Velocity and Magnetic Field*'', Solar Physics, 222, p61.

Lin, H., Penn, M.J.: 2004, ``*ATST Site Survey Sky Brightness Monitor*'' , PASP, 116, p652.

Penn, M.J., Cao, W.D., Walton, S.R., Chapman, G.A., Livingston, W., : 2003, ``*Imaging Spectropolarimetry of Ti I 2231nm in a Sunspot* '' , Solar Physics, 215, p87.

Penn, M.J., Cao, W.D., Walton, S.R., Chapman, G.A., Livingston, W.: 2003, ``*Weak Infrared Molecular Lines Reveal Rapid Outflow in Cool Magnetic Sunspot Penumbra Fibrils* '' , ApJ Letters, 590, L119.

Penn, M.J., Ceja, J.A., Bell, E., Frye, G., and Linck, R., 2002, ``*Infrared Spectroscopy from San Fernando Observatory: He I 1083nm, O I 1316nm, and Fe I 1565nm*'', Solar Physics, 205 p53

Lin, H., Penn, M.J. and Tomczyk, S., 2000, ``*A New Precise Measurement of the Coronal Magnetic Field Strength*'', ApJ Letters, 541, pL83

Penn, M.J., 1999, ``*New Measurements of the Solar Limb Emission in the O I 777.4 nm and 844.6 nm Lines*'', ApJ. Letters., 518, L131-134.

Lin, H., Penn, M.J., Kuhn, J.R., 1998 ``*He I 10830 A Line Polarimetry: A New Tool to Probe the Filament Magnetic Fields*'', Ap. J., 493, 978.

## BIOGRAPHICAL SKETCH

---

### **Synergistic Activities**

#### ***Recent Awards:***

AURA Tech. and Innovation Award (ATST Site Survey Group), 2005  
CSUN Julian Beck Teaching Award, 2000  
CSUN Faculty Research Award, 2000 & 1999

#### ***Service Committees:***

Served on numerous NASA proposal review panels including SDO and STEREO instrument reviews; leader of NSO ATST Coronal working group; member NSO ATST site survey working group; science and technical advisory group member, HAO Coronal Solar Magnetism Observatory.

#### ***Education:***

Faculty member of Department of Physics and Astronomy at CSUN; currently adjunct faculty at CSUN; taught and developed new courses; hired about one dozen undergraduates for research with external grant support; annually mentor one undergraduate via NSO Research Experience for Undergraduate (REU) program; Tucson site director for NSO REU program; research advisor for undergraduate independent research course at University of Arizona (UA) and University of Washington Seattle; currently advising UA graduate student for solar physics dissertation.

#### ***Public Outreach:***

Led visitor tours at NSO/Sac Peak 1991-1994; developed "Secrets of the Sun" slide set published by the ASP; Project Astro (Tucson) astronomer; directly mentored one summer teacher in NSO Research Experience for Teachers (RET) program; develop and participated in NOAO RBSE and TLRBSE programs for K-12 teachers; numerous scientific video interviews.

#### ***Instrumentation:***

For thesis worked on M CCD, a tip-tilt stabilized spatially scanning CCD spectrograph at University of Hawaii Mees Solar Observatory; collaborated with Lin and Kuhn at NSO/Sac Peak on infrared cameras; developed CSUN IRcam and polarimeter at CSUN San Fernando Observatory; completed NSO Array Camera, a 1kx1k 1-5 micron camera and polarimeter at NSO/Kitt Peak; collaborated with Lin on ATST Sky Brightness Monitor coronagraphic imager.

### **Collaborators and Other Affiliations**

Haosheng Lin	University of Hawaii
Steve Tomczyk	HAO
Debi Prasad Choudhary	California State University Northridge
Deqing Ren	CSUN

### **Graduate and Post-Doctoral Advisors(s)**

Barry LaBonte, deceased  
Raymond Smartt, retired and Jeff Kuhn, University of Hawaii

# SUMMARY PROPOSAL BUDGET

YEAR 1

ORGANIZATION <b>New Jersey Institute of Technology</b>				FOR NSF USE ONLY			
				PROPOSAL NO.	DURATION (months)		
PRINCIPAL INVESTIGATOR / PROJECT DIRECTOR <b>Philip Goode</b>				AWARD NO.	Proposed	Granted	
				A. SENIOR PERSONNEL: PI/PI, Co-PI's, Faculty and Other Senior Associates (List each separately with title, A.7. show number in brackets)			
				CAL	ACAD	SUMR	
1.	<b>Philip Goode - none</b>			0.00	0.00	0.00	\$ 0
2.	<b>Thomas R Ayres - none</b>			0.00	0.00	0.00	0
3.	<b>Wenda Cao - none</b>			0.00	0.00	0.00	0
4.	<b>Roy Coulter - none</b>			0.00	0.00	0.00	0
5.	<b>Matthew J Penn - none</b>			0.00	0.00	0.00	0
6.	( 0 ) OTHERS (LIST INDIVIDUALLY ON BUDGET JUSTIFICATION PAGE)			0.00	0.00	0.00	0
7.	( 5 ) TOTAL SENIOR PERSONNEL (1 - 6)			0.00	0.00	0.00	0
B. OTHER PERSONNEL (SHOW NUMBERS IN BRACKETS)							
1.	( 0 ) POST DOCTORAL SCHOLARS			0.00	0.00	0.00	0
2.	( 4 ) OTHER PROFESSIONALS (TECHNICIAN, PROGRAMMER, ETC.)			7.00	0.00	0.00	25,834
3.	( 0 ) GRADUATE STUDENTS						0
4.	( 0 ) UNDERGRADUATE STUDENTS						0
5.	( 0 ) SECRETARIAL - CLERICAL (IF CHARGED DIRECTLY)						0
6.	( 0 ) OTHER						0
TOTAL SALARIES AND WAGES (A + B)							25,834
C. FRINGE BENEFITS (IF CHARGED AS DIRECT COSTS)							7,724
TOTAL SALARIES, WAGES AND FRINGE BENEFITS (A + B + C)							33,558
D. EQUIPMENT (LIST ITEM AND DOLLAR AMOUNT FOR EACH ITEM EXCEEDING \$5,000.)							
	<b>Dewar/Camera</b>		\$ 760,380				
	<b>Mounting structure</b>		12,000				
TOTAL EQUIPMENT							772,380
E. TRAVEL							3,200
1. DOMESTIC (INCL. CANADA, MEXICO AND U.S. POSSESSIONS)							3,200
2. FOREIGN							0
F. PARTICIPANT SUPPORT COSTS							
1.	STIPENDS \$ _____		0				
2.	TRAVEL _____		0				
3.	SUBSISTENCE _____		0				
4.	OTHER _____		0				
TOTAL NUMBER OF PARTICIPANTS ( 0 )							
TOTAL PARTICIPANT COSTS							0
G. OTHER DIRECT COSTS							
1. MATERIALS AND SUPPLIES							0
2. PUBLICATION COSTS/DOCUMENTATION/DISSEMINATION							0
3. CONSULTANT SERVICES							0
4. COMPUTER SERVICES							0
5. SUBAWARDS							0
6. OTHER							0
TOTAL OTHER DIRECT COSTS							0
H. TOTAL DIRECT COSTS (A THROUGH G)							809,138
I. INDIRECT COSTS (F&A)(SPECIFY RATE AND BASE)							
<b>F&amp;A (Rate: 52.5000, Base: 36758)</b>							
TOTAL INDIRECT COSTS (F&A)							19,298
J. TOTAL DIRECT AND INDIRECT COSTS (H + I)							828,436
K. RESIDUAL FUNDS							0
L. AMOUNT OF THIS REQUEST (J) OR (J MINUS K)							\$ 828,436
M. COST SHARING PROPOSED LEVEL \$ <b>126,218</b>				AGREED LEVEL IF DIFFERENT \$			
PI/PI NAME <b>Philip Goode</b>				FOR NSF USE ONLY			
ORG. REP. NAME* <b>Maxine Kahn</b>				INDIRECT COST RATE VERIFICATION			
		Date Checked	Date Of Rate Sheet	Initials - ORG			

# SUMMARY PROPOSAL BUDGET

YEAR **2**

ORGANIZATION <b>New Jersey Institute of Technology</b>				FOR NSF USE ONLY			
				PROPOSAL NO.	DURATION (months)		
PRINCIPAL INVESTIGATOR / PROJECT DIRECTOR <b>Philip Goode</b>				AWARD NO.	Proposed	Granted	
A. SENIOR PERSONNEL: PI/PI, Co-PI's, Faculty and Other Senior Associates (List each separately with title, A.7. show number in brackets)				NSF Funded Person-months		Funds Requested By proposer	Funds granted by NSF (if different)
				CAL	ACAD	SUMR	
1.	<b>Philip Goode - none</b>			0.00	0.00	0.00	\$ 0
2.	<b>Thomas R Ayres - none</b>			0.00	0.00	0.00	0
3.	<b>Wenda Cao - none</b>			0.00	0.00	0.00	0
4.	<b>Roy Coulter - none</b>			0.00	0.00	0.00	0
5.	<b>Matthew J Penn - none</b>			0.00	0.00	0.00	0
6.	( 0 ) OTHERS (LIST INDIVIDUALLY ON BUDGET JUSTIFICATION PAGE)			0.00	0.00	0.00	0
7.	( 5 ) TOTAL SENIOR PERSONNEL (1 - 6)			0.00	0.00	0.00	0
B. OTHER PERSONNEL (SHOW NUMBERS IN BRACKETS)							
1.	( 0 ) POST DOCTORAL SCHOLARS			0.00	0.00	0.00	0
2.	( 5 ) OTHER PROFESSIONALS (TECHNICIAN, PROGRAMMER, ETC.)			11.00	0.00	0.00	43,556
3.	( 0 ) GRADUATE STUDENTS						0
4.	( 0 ) UNDERGRADUATE STUDENTS						0
5.	( 0 ) SECRETARIAL - CLERICAL (IF CHARGED DIRECTLY)						0
6.	( 0 ) OTHER						0
TOTAL SALARIES AND WAGES (A + B)							43,556
C. FRINGE BENEFITS (IF CHARGED AS DIRECT COSTS)							12,588
TOTAL SALARIES, WAGES AND FRINGE BENEFITS (A + B + C)							56,144
D. EQUIPMENT (LIST ITEM AND DOLLAR AMOUNT FOR EACH ITEM EXCEEDING \$5,000.)							
	<b>CT Optics and System, SG Optics, Transfer Optics, ...</b>			\$		114,322	
TOTAL EQUIPMENT							114,322
E. TRAVEL 1. DOMESTIC (INCL. CANADA, MEXICO AND U.S. POSSESSIONS)							3,200
2. FOREIGN							0
F. PARTICIPANT SUPPORT COSTS							
1.	STIPENDS \$ _____						0
2.	TRAVEL _____						0
3.	SUBSISTENCE _____						0
4.	OTHER _____						0
TOTAL NUMBER OF PARTICIPANTS ( 0 ) TOTAL PARTICIPANT COSTS							0
G. OTHER DIRECT COSTS							
1.	MATERIALS AND SUPPLIES						0
2.	PUBLICATION COSTS/DOCUMENTATION/DISSEMINATION						0
3.	CONSULTANT SERVICES						0
4.	COMPUTER SERVICES						0
5.	SUBAWARDS						0
6.	OTHER						0
TOTAL OTHER DIRECT COSTS							0
H. TOTAL DIRECT COSTS (A THROUGH G)							173,666
I. INDIRECT COSTS (F&A)(SPECIFY RATE AND BASE)							
<b>F&amp;A (Rate: 52.5000, Base: 59344)</b>							
TOTAL INDIRECT COSTS (F&A)							31,156
J. TOTAL DIRECT AND INDIRECT COSTS (H + I)							204,822
K. RESIDUAL FUNDS							0
L. AMOUNT OF THIS REQUEST (J) OR (J MINUS K)							\$ 204,822 \$
M. COST SHARING PROPOSED LEVEL \$ <b>200,308</b>				AGREED LEVEL IF DIFFERENT \$			
PI/PI NAME <b>Philip Goode</b>				FOR NSF USE ONLY			
ORG. REP. NAME* <b>Maxine Kahn</b>				INDIRECT COST RATE VERIFICATION			
		Date Checked		Date Of Rate Sheet		Initials - ORG	

# SUMMARY PROPOSAL BUDGET

YEAR 3

ORGANIZATION <b>New Jersey Institute of Technology</b>				FOR NSF USE ONLY			
				PROPOSAL NO.	DURATION (months)		
PRINCIPAL INVESTIGATOR / PROJECT DIRECTOR <b>Philip Goode</b>				AWARD NO.	Proposed	Granted	
A. SENIOR PERSONNEL: PI/PD, Co-PI's, Faculty and Other Senior Associates (List each separately with title, A.7. show number in brackets)				NSF Funded Person-months		Funds Requested By proposer	Funds granted by NSF (if different)
				CAL	ACAD	SUMR	
1.	<b>Philip Goode - none</b>			0.00	0.00	0.00	\$ 0
2.	<b>Thomas R Ayres - none</b>			0.00	0.00	0.00	0
3.	<b>Wenda Cao - none</b>			0.00	0.00	0.00	0
4.	<b>Roy Coulter - none</b>			0.00	0.00	0.00	0
5.	<b>Matthew J Penn - none</b>			0.00	0.00	0.00	0
6.	( 0 ) OTHERS (LIST INDIVIDUALLY ON BUDGET JUSTIFICATION PAGE)			0.00	0.00	0.00	0
7.	( 5 ) TOTAL SENIOR PERSONNEL (1 - 6)			0.00	0.00	0.00	0
B. OTHER PERSONNEL (SHOW NUMBERS IN BRACKETS)							
1.	( 0 ) POST DOCTORAL SCHOLARS			0.00	0.00	0.00	0
2.	( 5 ) OTHER PROFESSIONALS (TECHNICIAN, PROGRAMMER, ETC.)			11.00	0.00	0.00	46,419
3.	( 0 ) GRADUATE STUDENTS						0
4.	( 0 ) UNDERGRADUATE STUDENTS						0
5.	( 0 ) SECRETARIAL - CLERICAL (IF CHARGED DIRECTLY)						0
6.	( 0 ) OTHER						0
TOTAL SALARIES AND WAGES (A + B)							46,419
C. FRINGE BENEFITS (IF CHARGED AS DIRECT COSTS)							13,415
TOTAL SALARIES, WAGES AND FRINGE BENEFITS (A + B + C)							59,834
D. EQUIPMENT (LIST ITEM AND DOLLAR AMOUNT FOR EACH ITEM EXCEEDING \$5,000.)							
	<b>Dalsa Camera</b>		\$			30,000	
	<b>Tip Tilt Stage</b>					45,000	
TOTAL EQUIPMENT							75,000
E. TRAVEL 1. DOMESTIC (INCL. CANADA, MEXICO AND U.S. POSSESSIONS)							1,600
2. FOREIGN							0
F. PARTICIPANT SUPPORT COSTS							
1.	STIPENDS \$ _____						0
2.	TRAVEL _____						0
3.	SUBSISTENCE _____						0
4.	OTHER _____						0
TOTAL NUMBER OF PARTICIPANTS ( 0 )							TOTAL PARTICIPANT COSTS
							0
G. OTHER DIRECT COSTS							
1. MATERIALS AND SUPPLIES							0
2. PUBLICATION COSTS/DOCUMENTATION/DISSEMINATION							0
3. CONSULTANT SERVICES							0
4. COMPUTER SERVICES							0
5. SUBAWARDS							0
6. OTHER							0
TOTAL OTHER DIRECT COSTS							0
H. TOTAL DIRECT COSTS (A THROUGH G)							136,434
I. INDIRECT COSTS (F&A)(SPECIFY RATE AND BASE)							
<b>F&amp;A (Rate: 53.0000, Base: 61434)</b>							
TOTAL INDIRECT COSTS (F&A)							32,560
J. TOTAL DIRECT AND INDIRECT COSTS (H + I)							168,994
K. RESIDUAL FUNDS							0
L. AMOUNT OF THIS REQUEST (J) OR (J MINUS K)							\$ 168,994 \$
M. COST SHARING PROPOSED LEVEL \$ <b>134,607</b>				AGREED LEVEL IF DIFFERENT \$			
PI/PD NAME <b>Philip Goode</b>				FOR NSF USE ONLY			
ORG. REP. NAME* <b>Maxine Kahn</b>				INDIRECT COST RATE VERIFICATION			
		Date Checked		Date Of Rate Sheet		Initials - ORG	

# SUMMARY PROPOSAL BUDGET

YEAR 4

ORGANIZATION <b>New Jersey Institute of Technology</b>				FOR NSF USE ONLY			
				PROPOSAL NO.	DURATION (months)		
PRINCIPAL INVESTIGATOR / PROJECT DIRECTOR <b>Philip Goode</b>				AWARD NO.	Proposed	Granted	
				A. SENIOR PERSONNEL: PI/PI, Co-PI's, Faculty and Other Senior Associates (List each separately with title, A.7. show number in brackets)			
				CAL	ACAD	SUMR	
1.	<b>Philip Goode - none</b>			0.00	0.00	0.00	\$ 0
2.	<b>Thomas R Ayres - none</b>			0.00	0.00	0.00	0
3.	<b>Wenda Cao - none</b>			0.00	0.00	0.00	0
4.	<b>Roy Coulter - none</b>			0.00	0.00	0.00	0
5.	<b>Matthew J Penn - none</b>			0.00	0.00	0.00	0
6.	( 0 ) OTHERS (LIST INDIVIDUALLY ON BUDGET JUSTIFICATION PAGE)			0.00	0.00	0.00	0
7.	( 5 ) TOTAL SENIOR PERSONNEL (1 - 6)			0.00	0.00	0.00	0
B. OTHER PERSONNEL (SHOW NUMBERS IN BRACKETS)							
1.	( 0 ) POST DOCTORAL SCHOLARS			0.00	0.00	0.00	0
2.	( 5 ) OTHER PROFESSIONALS (TECHNICIAN, PROGRAMMER, ETC.)			12.00	0.00	0.00	56,822
3.	( 0 ) GRADUATE STUDENTS						0
4.	( 0 ) UNDERGRADUATE STUDENTS						0
5.	( 0 ) SECRETARIAL - CLERICAL (IF CHARGED DIRECTLY)						0
6.	( 0 ) OTHER						0
TOTAL SALARIES AND WAGES (A + B)							56,822
C. FRINGE BENEFITS (IF CHARGED AS DIRECT COSTS)							16,422
TOTAL SALARIES, WAGES AND FRINGE BENEFITS (A + B + C)							73,244
D. EQUIPMENT (LIST ITEM AND DOLLAR AMOUNT FOR EACH ITEM EXCEEDING \$5,000.)							
TOTAL EQUIPMENT							0
E. TRAVEL 1. DOMESTIC (INCL. CANADA, MEXICO AND U.S. POSSESSIONS)							0
2. FOREIGN							0
F. PARTICIPANT SUPPORT COSTS							
1.	STIPENDS \$ _____						0
2.	TRAVEL _____						0
3.	SUBSISTENCE _____						0
4.	OTHER _____						0
TOTAL NUMBER OF PARTICIPANTS ( 0 ) TOTAL PARTICIPANT COSTS							0
G. OTHER DIRECT COSTS							
1.	MATERIALS AND SUPPLIES						0
2.	PUBLICATION COSTS/DOCUMENTATION/DISSEMINATION						0
3.	CONSULTANT SERVICES						0
4.	COMPUTER SERVICES						0
5.	SUBAWARDS						0
6.	OTHER						0
TOTAL OTHER DIRECT COSTS							0
H. TOTAL DIRECT COSTS (A THROUGH G)							73,244
I. INDIRECT COSTS (F&A)(SPECIFY RATE AND BASE)							
<b>F&amp;A (Rate: 53.0000, Base: 73244)</b>							
TOTAL INDIRECT COSTS (F&A)							38,819
J. TOTAL DIRECT AND INDIRECT COSTS (H + I)							112,063
K. RESIDUAL FUNDS							0
L. AMOUNT OF THIS REQUEST (J) OR (J MINUS K)							\$ 112,063 \$
M. COST SHARING PROPOSED LEVEL \$ <b>102,146</b>				AGREED LEVEL IF DIFFERENT \$			
PI/PI NAME <b>Philip Goode</b>				FOR NSF USE ONLY			
ORG. REP. NAME* <b>Maxine Kahn</b>				INDIRECT COST RATE VERIFICATION			
		Date Checked		Date Of Rate Sheet		Initials - ORG	



# SUMMARY PROPOSAL BUDGET Cumulative

ORGANIZATION <b>New Jersey Institute of Technology</b>				FOR NSF USE ONLY			
				PROPOSAL NO.	DURATION (months)		
PRINCIPAL INVESTIGATOR / PROJECT DIRECTOR <b>Philip Goode</b>				AWARD NO.	Proposed	Granted	
A. SENIOR PERSONNEL: PI/PD, Co-PI's, Faculty and Other Senior Associates (List each separately with title, A.7. show number in brackets)				NSF Funded Person-months		Funds Requested By proposer	Funds granted by NSF (if different)
				CAL	ACAD	SUMR	
1.	<b>Philip Goode - none</b>			0.00	0.00	0.00	\$ 0
2.	<b>Thomas R Ayres - none</b>			0.00	0.00	0.00	0
3.	<b>Wenda Cao - none</b>			0.00	0.00	0.00	0
4.	<b>Roy Coulter - none</b>			0.00	0.00	0.00	0
5.	<b>Matthew J Penn - none</b>			0.00	0.00	0.00	0
6.	( ) OTHERS (LIST INDIVIDUALLY ON BUDGET JUSTIFICATION PAGE)			0.00	0.00	0.00	0
7.	( <b>5</b> ) TOTAL SENIOR PERSONNEL (1 - 6)			0.00	0.00	0.00	0
B. OTHER PERSONNEL (SHOW NUMBERS IN BRACKETS)							
1.	( <b>0</b> ) POST DOCTORAL SCHOLARS			0.00	0.00	0.00	0
2.	( <b>19</b> ) OTHER PROFESSIONALS (TECHNICIAN, PROGRAMMER, ETC.)			41.00	0.00	0.00	172,631
3.	( <b>0</b> ) GRADUATE STUDENTS						0
4.	( <b>0</b> ) UNDERGRADUATE STUDENTS						0
5.	( <b>0</b> ) SECRETARIAL - CLERICAL (IF CHARGED DIRECTLY)						0
6.	( <b>0</b> ) OTHER						0
TOTAL SALARIES AND WAGES (A + B)							172,631
C. FRINGE BENEFITS (IF CHARGED AS DIRECT COSTS)							50,149
TOTAL SALARIES, WAGES AND FRINGE BENEFITS (A + B + C)							222,780
D. EQUIPMENT (LIST ITEM AND DOLLAR AMOUNT FOR EACH ITEM EXCEEDING \$5,000.)							
							\$ 961,702
TOTAL EQUIPMENT							961,702
E. TRAVEL 1. DOMESTIC (INCL. CANADA, MEXICO AND U.S. POSSESSIONS)							8,000
2. FOREIGN							0
F. PARTICIPANT SUPPORT COSTS							
1.	STIPENDS \$ _____						0
2.	TRAVEL _____						0
3.	SUBSISTENCE _____						0
4.	OTHER _____						0
TOTAL NUMBER OF PARTICIPANTS ( <b>0</b> ) TOTAL PARTICIPANT COSTS							0
G. OTHER DIRECT COSTS							
1. MATERIALS AND SUPPLIES							0
2. PUBLICATION COSTS/DOCUMENTATION/DISSEMINATION							0
3. CONSULTANT SERVICES							0
4. COMPUTER SERVICES							0
5. SUBAWARDS							0
6. OTHER							0
TOTAL OTHER DIRECT COSTS							0
H. TOTAL DIRECT COSTS (A THROUGH G)							1,192,482
I. INDIRECT COSTS (F&A)(SPECIFY RATE AND BASE)							
TOTAL INDIRECT COSTS (F&A)							121,833
J. TOTAL DIRECT AND INDIRECT COSTS (H + I)							1,314,315
K. RESIDUAL FUNDS							0
L. AMOUNT OF THIS REQUEST (J) OR (J MINUS K)							\$ 1,314,315
M. COST SHARING PROPOSED LEVEL \$ <b>563,279</b>				AGREED LEVEL IF DIFFERENT \$			
PI/PD NAME <b>Philip Goode</b>				FOR NSF USE ONLY			
ORG. REP. NAME* <b>Maxine Kahn</b>				INDIRECT COST RATE VERIFICATION			
		Date Checked		Date Of Rate Sheet		Initials - ORG	

C \*ELECTRONIC SIGNATURES REQUIRED FOR REVISED BUDGET

## D Budget Justification

*The budget requested from NSF for the CIRS Project is \$1,314 K. The total budget is \$1,877 K, which includes a match of \$563 K from NJIT. As well, NJIT faculty and senior members of the CIRS Team will be working on the CIRS Project with no charge. The contribution here is difficult to know exactly, but it amounts to about 1 FTE. The largest equipment expenditure is \$772 K for the cryostat and 1-5  $\mu\text{m}$  camera (ALADDIN-II, InSb) and the mounting structure for the system. This expenditure will be made in the first year after the final design review. In the second year, the internal and external optics of the CIRS will be purchased for a total of \$185 K (split \$114 K from the NSF and \$71 K from NJIT). The largest items here include the grating (\$39 K), the collimator (\$44 K), a series of filters and slits (\$65 K) and the remaining items are individually less than \$10 K. In the third year, we will spend a total of \$75 K split between the tip/tilt stage (\$45 K) and image acquisition system (\$30 K) for the correlation tracker system. There are no equipment purchases in the fourth and final year of the project.*

The remainder of the budget is dominated by personnel costs of about one FTE per year over the four year project. As well, NJIT will match with about three-quarters of an FTE per year. Over the length of the project, NJIT will match with two months per year of co-PI Roy Coulter's time and thirteen months (over the project) of Nicolas Gorceix's time. Coulter will manage and coordinate the diverse elements of the project and oversee the optical and mechanical design and operation of the system. Nicolas Gorceix, the BBSO optical engineer, will complete the CIRS optical design, identify vendors, oversee purchasing and assist with integration and testing. Coulter and Gorceix have already made the strawman design of CIRS. Prof. Wenda Cao is an expert in instrumentation and spectrographs, in particular. Cao will work closely with Coulter and Gorceix. As well, Matt Penn, Thomas Ayres and Phil Goode charge no time to the project, but will work to ensure the success of the CIRS Project. Penn leads the IR instrumentation efforts at the McMath-Pierce telescope and Ayres is an expert in both the NIR and spectroscopic efforts to explore that spectral regime. They will be critical in ensuring optimal possible specifications are

identified and met are met by CIRS. Goode has overall responsibility for BBSO and will coordinate efforts among the commissioning efforts of the NST, including CIRS. Cao and Goode will be responsible for the PhD students who will work, in part on CIRS, and be supported by BBSO's current five-year "backbone" NSF grant that is in its first year and Cao's five year NSF Career Award that is just beginning. The effort of these personnel will be focussed on all aspects of implementing the CIRS system. co-PI Roy Coulter will oversee training of observing staff and production of documentation, maintenance, and user manuals.

We request funds to support 3.5 FTE's of engineers over the length of the four year CIRS project. This includes six months of time of BBSO's electronic engineer, Vlad Abramenko, will design and build the electronic interfaces and control hardware; and ten months of time of Sergey Shumko to handle all high level software included interfacing CIRS to the NST Telescope Control System and participate in integration, testing and initial operations of CIRS; and ten months of mechanical engineer Jeff Nenow's time to be responsible for on-site fabrication and assist with assembly; and finally sixteen months of mechanical engineer Aaron Coulter's time to be responsible for mechanical design, outside fabrication contracts, machine control, along with integration and testing.

The travel budget is primarily for collaborating personnel travel between BBSO, NSO/T and CU.

The team is lean, but has already demonstrated its prowess on the the NST project.

## Current and Pending Support

(See GPG Section II.C.2.h for guidance on information to include on this form.)

The following information should be provided for each investigator and other senior personnel. Failure to provide this information may delay consideration of this proposal.	
Investigator: Philip Goode	Other agencies (including NSF) to which this proposal has been/will be submitted.
Support: <input checked="" type="checkbox"/> Current <input type="checkbox"/> Pending <input type="checkbox"/> Submission Planned in Near Future <input type="checkbox"/> *Transfer of Support Project/Proposal Title: (PI) High Resolution Studies of Solar Activity with New Solar Telescope  Source of Support:       NSF-GEO/ATM Total Award Amount: \$ 1,500,000 Total Award Period Covered: 04/01/08 - 03/31/13 Location of Project:     BBSO/NJIT Person-Months Per Year Committed to the Project.   Cal:0.00   Acad: 2.00   Sumr: 1.00	
Support: <input checked="" type="checkbox"/> Current <input type="checkbox"/> Pending <input type="checkbox"/> Submission Planned in Near Future <input type="checkbox"/> *Transfer of Support Project/Proposal Title: (PI) Studies of Solar Activity with Coordinated Observations of New Solar Telescope and NASA Solar Physics Mission  Source of Support:       NASA Total Award Amount: \$ 1,500,000 Total Award Period Covered: 01/01/09 - 12/31/11 Location of Project:     BBSO/NJIT Person-Months Per Year Committed to the Project.   Cal:0.00   Acad: 2.00   Sumr: 2.00	
Support: <input checked="" type="checkbox"/> Current <input type="checkbox"/> Pending <input type="checkbox"/> Submission Planned in Near Future <input type="checkbox"/> *Transfer of Support Project/Proposal Title: (PI) Solar B_Phase E Support  Source of Support:       Lockheed Martin Corp./NASA Total Award Amount: \$ 540,000 Total Award Period Covered: 11/01/06 - 10/31/10 Location of Project:     BBSO/NJIT Person-Months Per Year Committed to the Project.   Cal:0.00   Acad: 0.50   Sumr: 0.00	
Support: <input checked="" type="checkbox"/> Current <input type="checkbox"/> Pending <input type="checkbox"/> Submission Planned in Near Future <input type="checkbox"/> *Transfer of Support Project/Proposal Title: (PI) Helioseismic and Magnetic Imager  Source of Support:       Stanford University/NASA Total Award Amount: \$ 279,000 Total Award Period Covered: 05/01/05 - 05/31/10 Location of Project:     BBSO/NJIT Person-Months Per Year Committed to the Project.   Cal:0.00   Acad: 0.20   Sumr: 0.00	
Support: <input checked="" type="checkbox"/> Current <input type="checkbox"/> Pending <input type="checkbox"/> Submission Planned in Near Future <input type="checkbox"/> *Transfer of Support Project/Proposal Title: (PI) Next Generation Synoptic Telescope for Innovative Space Weather Research  Source of Support:       AFOSR Total Award Amount: \$ 211,725 Total Award Period Covered: 06/01/08 - 05/31/09 Location of Project:     BBSO Person-Months Per Year Committed to the Project.   Cal:0.00   Acad: 0.50   Summ: 0.00	
*If this project has previously been funded by another agency, please list and furnish information for immediately preceding funding period.	



## CURRENT AND PENDING SUPPORT

Co-Investigator: Dr. Thomas Ayres

### **Current Support:**

Project/Proposal Title: Expanding the Horizons of Stellar Activity Beyond the Solar

Neighborhood: Quantifying Physical Processes Through Larger Samples

Source of Support: NASA NAG5-13058

Project Location: University of Colorado at Boulder

Total Award Amount: \$589,000

Starting Date: 06/01/03

Ending Date: 05/31/09

Person-months Per Year Committed to the Project: Academic: 3.0

Project/Proposal Title: Coronal Data Analysis (Grad Student Support)

Source of Support: Southwest Research Institute NAG5-11595

Project Location: University of Colorado at Boulder

Total Award Amount: \$234,683

Starting Date: 06/07/04

Ending Date: 04/30/09

Person-months Per Year Committed to the Project: Academic: 0.0

Project/Proposal Title: Fluxon Modeling of CME Onset (Grad Student Support)

Source of Support: Southwest Research Institute NNG05GK14G

Project Location: University of Colorado at Boulder

Total Award Amount: \$114,876

Starting Date: 02/13/06

Ending Date: 05/14/09

Person-months Per Year Committed to the Project: Academic: 0.0

Project/Proposal Title: The Oxygen Crisis

Source of Support: NSF AST 0607295

Project Location: University of Colorado at Boulder

Total Award Amount: \$192,808

Starting Date: 08/01/06

Ending Date: 07/31/09

Person-months Per Year Committed to the Project: Academic: 2.4

Project/Proposal Title: Deep Grism Survey of the Hyades Cluster

Source of Support: NASA NNX08AE19G

Project Location: University of Colorado at Boulder

Total Award Amount: \$67,000

Starting Date: 12/28/07

Ending Date: 12/27/08

Person-months Per Year Committed to the Project: Academic: 2.8

Project/Proposal Title: Anomalous Coronae of Hertzsprung Gap Giants

Source of Support: NASA NNX08AM60G

Project Location: University of Colorado at Boulder

Total Award Amount: \$17,269  
Starting Date: 5/01/08  
Ending Date: 04/30/09  
Person-months Per Year Committed to the Project: Academic: 1.0

Project/Proposal Title: The Further Fainting of Alpha Cen A  
Source of Support: SAO G08-9007X  
Project Location: University of Colorado at Boulder  
Total Award Amount: \$38,652  
Starting Date: 1/8/08  
Ending Date: 01/07/09  
Person-months Per Year Committed to the Project: Academic: 1.5

Project/Proposal Title: Filling in the Coronal Graveyard  
Source of Support: SAO G08-9010X  
Project Location: University of Colorado at Boulder  
Total Award Amount: \$33,589  
Starting Date: 06/10/08  
Ending Date: 06/09/09  
Person-months Per Year Committed to the Project: Academic: 1.0

Project/Proposal Title: Strip-Mining the Coronal Graveyard  
Source of Support: NASA NNX08AW85G  
Project Location: University of Colorado at Boulder  
Total Award Amount: \$43,900  
Starting Date: 07/21/08  
Ending Date: 07/20/09  
Person-months Per Year Committed to the Project: Academic: 1.5

Project/Proposal Title: Supervised Laboratory Assistance (grad student support)  
Source of Support: Southwest Research Institute NNX08AH43G  
Project Location: University of Colorado at Boulder  
Total Award Amount: \$81,045  
Starting Date: 05/01/08  
Ending Date: 04/30/11  
Person-months Per Year Committed to the Project: Academic: 0.0

Project/Proposal Title: RAISE Sounding Rocket Program (grad student support)  
Source of Support: Southwest Research Institute NNX08AC58G  
Project Location: University of Colorado at Boulder  
Total Award Amount: \$17,685  
Starting Date: 09/01/08  
Ending Date: 05/31/09  
Person-months Per Year Committed to the Project: Academic: 0.0

Project/Proposal Title: Deep Grism Survey of the Hyades Cluster II  
Source of Support: NASA Galex  
Project Location: University of Colorado at Boulder

Total Award Amount: \$94,000  
Starting Date: 11/01/08  
Ending Date: 10/31/09  
Person-months Per Year Committed to the Project: Academic: 3.5

**Pending Support:**

Project/Proposal Title: The Solar Oxygen Problem: Crisis, Catastrophe, or Opportunity?

Source of Support: NSF SSE

Project Location: University of Colorado at Boulder

Total Award Amount: \$226,398

Starting Date: 08/01/09

Ending Date: 07/31/12

Person-months Per Year Committed to the Project: Academic: 2.5

Project/Proposal Title: The Cycles of Alpha Centauri

Source of Support: STScI

Project Location: University of Colorado at Boulder

Total Award Amount: \$49,044

Starting Date: 12/01/08

Ending Date: 11/30/09

Person-months Per Year Committed to the Project: Academic: 1.7

Project/Proposal Title: The Cycles of Alpha Centauri

Source of Support: SAO cycle 10

Project Location: University of Colorado at Boulder

Total Award Amount: \$32,100

Starting Date: 01/01/09

Ending Date: 12/31/10

Person-months Per Year Committed to the Project: Academic: 1.3

Project/Proposal Title: SNAPing Coronal Iron

Source of Support: STScI

Project Location: University of Colorado at Boulder

Total Award Amount: \$100,838

Starting Date: 12/01/08

Ending Date: 11/30/09

Person-months Per Year Committed to the Project: Academic: 4.0

Project/Proposal Title: Ironing out the Wrinkles

Source of Support: STScI

Project Location: University of Colorado at Boulder

Total Award Amount: \$103,852

Starting Date: 12/01/08

Ending Date: 11/30/09

Person-months Per Year Committed to the Project: Academic: 4.0

## Current and Pending Support

(See GPG Section II.C.2.h for guidance on information to include on this form.)

The following information should be provided for each investigator and other senior personnel. Failure to provide this information may delay consideration of this proposal.	
Investigator: Wenda Cao	Other agencies (including NSF) to which this proposal has been/will be submitted.
<p>Support:   <input checked="" type="checkbox"/> Current   <input type="checkbox"/> Pending   <input type="checkbox"/> Submission Planned in Near Future   <input type="checkbox"/> *Transfer of Support</p> <p>Project/Proposal Title: (Co-PI) High Resolution Studies of Solar Activity with New Solar Telescope</p> <p>Source of Support:       NSF-GEO/ATM</p> <p>Total Award Amount: \$ 1,500,000 Total Award Period Covered: 04/01/08 - 03/31/13</p> <p>Location of Project:     BBSO/NJIT</p> <p>Person-Months Per Year Committed to the Project.   Cal:0.00   Acad: 0.00   Sumr: 1.00</p>	
<p>Support:   <input checked="" type="checkbox"/> Current   <input type="checkbox"/> Pending   <input type="checkbox"/> Submission Planned in Near Future   <input type="checkbox"/> *Transfer of Support</p> <p>Project/Proposal Title: (Co-PI) Studies of Solar Activity with Coordinated Observations of New Solar Telescope and NASA Solar Physics Mission</p> <p>Source of Support:       NASA</p> <p>Total Award Amount: \$ 1,500,000 Total Award Period Covered: 01/01/09 - 12/31/11</p> <p>Location of Project:     BBSO/NJIT</p> <p>Person-Months Per Year Committed to the Project.   Cal:0.00   Acad: 0.00   Sumr: 1.00</p>	
<p>Support:   <input checked="" type="checkbox"/> Current   <input type="checkbox"/> Pending   <input type="checkbox"/> Submission Planned in Near Future   <input type="checkbox"/> *Transfer of Support</p> <p>Project/Proposal Title: (PI) Developing High Resolution Infrared Instrumentation to Explore Solar Activity</p> <p>Source of Support:       NSF-CAREER</p> <p>Total Award Amount: \$ 488,835 Total Award Period Covered: 02/01/09 - 01/31/14</p> <p>Location of Project:     NJIT</p> <p>Person-Months Per Year Committed to the Project.   Cal:0.00   Acad: 2.00   Sumr: 0.00</p>	
<p>Support:   <input type="checkbox"/> Current   <input checked="" type="checkbox"/> Pending   <input type="checkbox"/> Submission Planned in Near Future   <input type="checkbox"/> *Transfer of Support</p> <p>Project/Proposal Title: (PI) Development of Near Infrared Dual Fabry-Perot Imaging Spectro-polarimeter</p> <p>Source of Support:       AFOSR</p> <p>Total Award Amount: \$ 156,185 Total Award Period Covered: 04/15/09 - 04/15/10</p> <p>Location of Project:     BBSO</p> <p>Person-Months Per Year Committed to the Project.   Cal:0.00   Acad: 0.50   Sumr: 0.50</p>	
<p>Support:   <input type="checkbox"/> Current   <input checked="" type="checkbox"/> Pending   <input type="checkbox"/> Submission Planned in Near Future   <input type="checkbox"/> *Transfer of Support</p> <p>Project/Proposal Title: (Co-PI) Development of High-Order Adaptive Optics for 1.6 Meter Solar Telescope in Big Bear</p> <p>Source of Support:       NSF-AST/ATI</p> <p>Total Award Amount: \$ 895,792 Total Award Period Covered: 06/01/09 - 05/31/12</p> <p>Location of Project:     BBSO</p> <p>Person-Months Per Year Committed to the Project.   Cal:0.00   Acad: 1.00   Summ: 0.00</p>	
*If this project has previously been funded by another agency, please list and furnish information for immediately preceding funding period.	



## Current and Pending Support

(See GPG Section II.C.2.h for guidance on information to include on this form.)

The following information should be provided for each investigator and other senior personnel. Failure to provide this information may delay consideration of this proposal.	
Investigator: Wenda Cao	Other agencies (including NSF) to which this proposal has been/will be submitted.
Support: <input type="checkbox"/> Current <input checked="" type="checkbox"/> Pending <input type="checkbox"/> Submission Planned in Near Future <input type="checkbox"/> *Transfer of Support Project/Proposal Title:   (Co-PI) MRI: Development of Cryogenic Infrared Spectrograph for the 1.6 Meter Solar Telescope in Big Bear  Source of Support:   NSF-MRI/ATM Total Award Amount: \$   1,314,315   Total Award Period Covered:   07/01/09 - 06/30/13 Location of Project:   BBSO/NJIT Person-Months Per Year Committed to the Project.   Cal:0.00   Acad:2.00   Sumr: 0.00	
Support: <input type="checkbox"/> Current <input type="checkbox"/> Pending <input type="checkbox"/> Submission Planned in Near Future <input type="checkbox"/> *Transfer of Support Project/Proposal Title:  Source of Support: Total Award Amount: \$                      Total Award Period Covered: Location of Project: Person-Months Per Year Committed to the Project.   Cal:              Acad:              Sumr:	
Support: <input type="checkbox"/> Current <input type="checkbox"/> Pending <input type="checkbox"/> Submission Planned in Near Future <input type="checkbox"/> *Transfer of Support Project/Proposal Title:  Source of Support: Total Award Amount: \$                      Total Award Period Covered: Location of Project: Person-Months Per Year Committed to the Project.   Cal:              Acad:              Sumr:	
Support: <input type="checkbox"/> Current <input type="checkbox"/> Pending <input type="checkbox"/> Submission Planned in Near Future <input type="checkbox"/> *Transfer of Support Project/Proposal Title:  Source of Support: Total Award Amount: \$                      Total Award Period Covered: Location of Project: Person-Months Per Year Committed to the Project.   Cal:              Acad:              Sumr:	
Support: <input type="checkbox"/> Current <input type="checkbox"/> Pending <input type="checkbox"/> Submission Planned in Near Future <input type="checkbox"/> *Transfer of Support Project/Proposal Title:  Source of Support: Total Award Amount: \$                      Total Award Period Covered: Location of Project: Person-Months Per Year Committed to the Project.   Cal:              Acad:              Summ:	

\*If this project has previously been funded by another agency, please list and furnish information for immediately preceding funding period.



## Current and Pending Support

(See GPG Section II.C.2.h for guidance on information to include on this form.)

The following information should be provided for each investigator and other senior personnel. Failure to provide this information may delay consideration of this proposal.	
Investigator: <b>Matthew Penn</b>	Other agencies (including NSF) to which this proposal has been/will be submitted.
Support: <input checked="" type="checkbox"/> Current <input type="checkbox"/> Pending <input type="checkbox"/> Submission Planned in Near Future <input type="checkbox"/> *Transfer of Support Project/Proposal Title:    (PI) REU Site Program at the National Solar Observatory (NSO)	
Source of Support:    NSF Total Award Amount: \$    174,000    Total Award Period Covered:    06/01/09 - 05/31/12 Location of Project:    NSO Sites in Tucson, AZ and Sunspot (Sacramento Peak), NM Person-Months Per Year Committed to the Project.    Cal:0.00    Acad:0.00    Sumr: 1.40	
Support: <input type="checkbox"/> Current <input type="checkbox"/> Pending <input type="checkbox"/> Submission Planned in Near Future <input type="checkbox"/> *Transfer of Support Project/Proposal Title:	
Source of Support: Total Award Amount: \$                      Total Award Period Covered: Location of Project: Person-Months Per Year Committed to the Project.    Cal:              Acad:              Sumr:	
Support: <input type="checkbox"/> Current <input type="checkbox"/> Pending <input type="checkbox"/> Submission Planned in Near Future <input type="checkbox"/> *Transfer of Support Project/Proposal Title:	
Source of Support: Total Award Amount: \$                      Total Award Period Covered: Location of Project: Person-Months Per Year Committed to the Project.    Cal:              Acad:              Sumr:	
Support: <input type="checkbox"/> Current <input type="checkbox"/> Pending <input type="checkbox"/> Submission Planned in Near Future <input type="checkbox"/> *Transfer of Support Project/Proposal Title:	
Source of Support: Total Award Amount: \$                      Total Award Period Covered: Location of Project: Person-Months Per Year Committed to the Project.    Cal:              Acad:              Sumr:	
Support: <input type="checkbox"/> Current <input type="checkbox"/> Pending <input type="checkbox"/> Submission Planned in Near Future <input type="checkbox"/> *Transfer of Support Project/Proposal Title:	
Source of Support: Total Award Amount: \$                      Total Award Period Covered: Location of Project: Person-Months Per Year Committed to the Project.    Cal:              Acad:              Summ:	

\*If this project has previously been funded by another agency, please list and furnish information for immediately preceding funding period.

January 20, 2009

Office of Integrative Activities National Science Foundation  
Major Research Instrumentation Program  
4201 Wilson Blvd. Arlington, VA 22230

Dear NSF Program Manager:

I am pleased to write on behalf of Professor Phil Goode's application to this year's National Science Foundation Major Research Instrumentation program. This instrumentation fabrication proposal seeks to develop a Cryogenic InfraRed Spectrograph (CIRS) for use at our Big Bear Solar Observatory as part of the suite of systems supporting the New Solar Telescope (NST). We expect NST to remain the world's largest ground-based solar observatory for at least a decade and it will serve as the premier resource for the global solar physics community. CIRS will be the only fully cryogenic IR solar spectrograph that will enable the NST to provide the global research community with unique data on the solar magnetic field.

NJIT will match the NSF funding through the commitment of NJIT-BBSO staff and allied faculty time dedicated to the design and fabrication of this device. The total of this support amounts to 30% of the total project cost, and does not count ancillary investments made to facilitate the launch and ongoing operation of NST. If you have any further questions about the match please contact me directly.

Cordially,



Donald H. Sebastian, Ph.D.

Provost (Interim) & Sr. Vice President for Research & Development



New Jersey Institute of Technology  
University Heights  
Newark, NJ 07102-1982  
973.596.8449  
973.596.6056 fax  
sebastian@njit.edu

**Donald H. Sebastian, Ph.D.**  
*Provost (Interim) and  
Sr. Vice President for R&D*

January 20, 2009

Office of Integrative Activities National Science Foundation  
Major Research Instrumentation Program  
4201 Wilson Blvd. Arlington, VA 22230

Dear NSF Program Manager:

This letter certifies that NJIT is one of three public, doctoral universities in the state of New Jersey. It offers the Ph.D. degree across nineteen different programs, graduating more than 50 Ph.D. candidates per year. Please contact me if you need any additional data on our academic enterprise.

Cordially,

A handwritten signature in black ink, appearing to read "D. Sebastian", is written over a horizontal line.

Donald H. Sebastian, Ph.D.  
Provost (Interim) & Sr. Vice President for Research & Development

# IRLabs

## Infrared Laboratories

1808 EAST 17th STREET  
TUCSON, ARIZONA 85719  
PHONE (520) 622-7074  
FAX (520) 623-0765

Big Bear Solar Observatory  
40386 North Shore Lane  
Big Bear City, CA 92315

ROM # \_BBSO01CA090121\_

### ITEM PART / DESCRIPTION / DETAIL

- 1 Custom mechanically cooled 1024 x 1024 InSb camera which includes the following features:
  - Vacuum Enclosure, ~ 62.0" x 24.0" x 24.0 (internal dimensions) tall with internal aluminum optics plate, radiation shield, and rigid supports system.
  - Two (2) Sumitomo cryo-coolers. A single stage for cooling the FPA, a dual stage for the optics plate and shield
  - Reduced custom low vibration mounting system for cryo-coolers (Internal and external)
  - Raytheon 1024 x 1024 Science grade ALADDIN InSb array, and bare MUX
  - Thirty-two (32) output FPA controller electronics with external cabling
  - Custom InSb Array mount on a motorized focus adjustment slide. Includes internal cryogenic motor and slide mechanism.
  - Custom ALADDIN sister/fan-out board with spring load socket.
  - Temperature controlled stage for array mount. Base temperature of array prior to temperature control < 30K (System does not include the temperature controller)
  - Internal 10 position motorized filter wheel, with low background modification. Filter size 1.0" x 0.250" deep
  - Motorized Turret/rotation mechanism for grating/mirror
  - Rack mount motor drive controller with power supply, drivers, and indexer installed for three (3) motors
  - Three silicon diodes (temperature sensors)
    - One on temperature controlled stage
    - One on optics plate
    - One on shield (NOTE: the optic plate and shield sensors will be on removable mounts, so that customer may position the sensor at their desired locations)
  - Caf2 window, 2.0" diameter, CA= 30 mm
  - FOV Baffling on shield
  - All internal wiring, array, motors, and housekeeping
  - Hermetic electrically connectors installed on deep pocket vacuum flanges for all required functions (array-2 each—motor, and housekeeping)
  - Internal wiring heat sinks so that entire cable assemblies can be removed thru the opening in the case without de-soldering any connections.
  - Integration, testing and documentations (Does not included optical alignment or installation of customer supplied optical components)
  - Custom Dewar Cart
  - Custom wooden shipping containers

# IRLabs

## Infrared Laboratories

The ROM DOES NOT include:

- Optical mounts or optics
- Optical alignment
- Installation of any optical components, less Caf2 window
- Internal FOV baffling for low-background of FPA
- Temperature controller for stage
- Full Integration of FPA
- System set-up at Big Bear Solar Observatory

Delivery estimated at 12 month after ARO and approval of preliminary design.  
Progress payments MAY be required.

**TOTAL ROM PRICE    \$ 760,380.00**

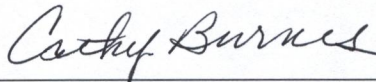

---

Cathy Burnes, Contracts Manager



# Newport Corporation

Corporate Headquarters  
 1791 Deere Avenue, Irvine,  
 CA 92606  
 USA  
 Tel (800) 222-6440 Fax (949) 253-1680

**Rochester Office**  
 705 St. Paul Street,  
 Rochester, NY 14605 USA  
 Tel (585) 262-1331 Fax (585) 454-1568

**Newport®**

Experience | Solutions

# Quotation

**Sold-To**  
 BIG BEAR SOLAR CONSERVATORY  
 40386 NORTH SHORE LANE  
 BIG BEAR CITY CA 92314  
 USA  
 Contact: Roy Coulter  
 Tel # : 909-866-5791EXT:19  
 Fax : 909-866-4240  
 Email: coulter@bbsso.njit.edu

**Information**  
**Quotation Number:** 1021870  
**Customer Reference No:**  
**Customer No:** 1007081  
**Currency:** USD  
**Validity End Date:** 01/16/2009  
**Quotation Date:** 12/15/2008

**Terms of Payment:** CREDIT CARD PAYMENT  
**Terms of Delivery:** PPA FOB ORIGIN  
 Prepaid & Add

Line	Item /Description	Unit Base Price	Unit Net Price	Quantity	Total Amount
100	53E	39,100.00	39,100.00	1	39,100.00
	Plane Echelle Reflection Grating				
	<b>With the following configuration</b>				
	Newport Catalog Number	53999ZD06-401E			
	Groove Frequency	79 g/mm			
	Blaze Angle	63 degrees			
	Blaze Wavelength	All Wavelengths			
	Substrate Size	Special Size			
	Material	Schott Zerodur			
	Coating	Protected Silver			
	Substrate Size	Special Size			
	Substrate Dimension Type	Special			
	Groove Length - Special	100.0			
	Ruled Width - Special	408.0			
	Substrate Shape - Special	Rectangular			
	Substrate Length - Special	110.0			
	Substrate Width - Special	420.0			
	<b>- Provide S- and P-plane efficiency for blaze orders near 250 nm, 540 nm, and 1.0 um.</b>				
	<b>Lead time is 16-18 weeks ARO.</b>				
<b>Item Total</b>					<b>USD 39,100.00</b>
Gross Value					39,100.00
Net Value					39,100.00
<b>Total amount:</b>					<b>USD 39,100.00</b>





## Newport Corporation

Corporate Headquarters  
1791 Deere Avenue, Irvine,  
CA 92606  
USA

Tel (800) 222-6440 Fax (949) 253-1680

## Rochester Office

705 St. Paul Street,  
Rochester, NY 14605 USA

Tel (585) 262-1331 Fax (585) 454-1568

Page 2 of 2

12/15/2008

**Newport®**

Experience | Solutions

# Quotation

The purchase and sale of the products reflected in this quotation shall be governed by the terms and conditions contained on the face of this quotation and in the Newport Corporation Terms and Conditions of Sale attached hereto and incorporated herein by reference.

Unless otherwise stated herein, shipping and handling charges are not included in the price. Any quoted shipping and handling charges are estimates only. Unless expressly stated in the quotation, offers for vibration control products including optical tables, isolation legs and workstations DO NOT include rigging and installation to their final use destination. Upon request, Newport can provide experienced references for these services.

Prices quoted are domestic prices for shipments within the U.S.A. only. Products destined for export are subject to international pricing. If customer intends to export products, customer must notify Newport and obtain a revised quotation. All product warranties may be voided at Newport's discretion if products are re-exported outside of the U.S.A without Newport's express written approval.

The terms of payment stated above are subject to credit approval. Availability of product included in this quote is subject to prior sale.

Please reference the quotation number above when placing your order.

**For technical questions, please contact:**

**Sarah Curet**

Sales Engineer, Scientific

Tel # : 585-248-4235

Roy Coulter  
Big Bear Solar Observatory  
40386 N. Shore Lane  
Big Bear City, CA 92314

Phone: 909-866-5791

Email: coulter@bbso.njit.edu

Subject: **PI Quote # 0901-56**

Dear Roy:

Thank you for your request. We are pleased to provide the following quotation for our Physik Instrumente products.

**Tip/Tilt Piezo Flexure Stages:**

Item	Qty	Part Number	Description	Price	Ext. Price
1	1	S-330.2SL	Piezo Tip/Tilt Platform, 2 mrad (4 mrad Optical), Closed-Loop, SGS, LEMO	\$6,219.00	\$6,219.00
2	1	S-330.4SL	Piezo Tip/Tilt Platform, 5mrad (10 mrad Optical), Closed-Loop, SGS, LEMO	\$6,972.00	\$6,972.00
3	1	S-330.8SL	Piezo Tip/Tilt Platform, 10mrad (20 mrad Optical), Closed-Loop, LEMO	\$7,766.00	\$7,766.00

**Recommended Controller:**

4	1	E-501.00	Piezo Controller Basic Chassis 9.5, w/ Multi-Voltage Power Supply"	\$1,692.00	\$1,692.00
5	1	E-503.00	LVPZT Piezo Amplifier Module -20 to 120V, 3 Channels	\$2,776.00	\$2,776.00
6	1	E-509.S3	Sensor & Position Servo-Control Module for Piezo-Driven Nanopositioning Systems, Strain Gauge Sensor, 3 Channels	\$3,290.00	\$3,290.00
<b>OPTIONAL Display and Interface Module</b>					
7	1	E-516.I3	Display/Interface Module 20 Bit, IEEE488/RS232, 3 Channels	\$4,212.00	\$4,212.00
				<b>Controller Subtotal</b>	<b>\$11,970.00</b>

Lead Time: 5-8 weeks ARO depending on the stage selected.

If you have any questions please don't hesitate to call me at (949) 679-9191 or email me at the address below. We appreciate your interest and look forward to serving you.

Best Regards,

James B. Deichmann  
Regional Sales Manager  
[jamesd@pi-usa.us](mailto:jamesd@pi-usa.us)  
Tel: (949) 679-9191 ext 25

**PI (Physik Instrumente) L.P.**

Head Office: 16 Albert Street, Auburn, MA 01501  
Tel: 508-832-3456 Fax: 508-832-0506 Email: info@pi-usa.us

West Coast: 5420 Trabuco Road, Ste. 100, Irvine, CA 92620  
Office Tel: 949-679-9191 Fax: 949-679-9292

## Addendum: Ordering and Warranty Information

All **PI** products can be ordered through the following address:

PI (Physik Instrumente) L.P.  
16 Albert Street  
Auburn, MA 01501

508-832 3456 (phone)  
508-832 0506 (Fax)

All products or systems quoted are guaranteed to be free of defects in materials or workmanship for a period of one year from date of invoice. Piezoelectric products are not warranted against mechanical damage resulting from improper use wherein excessive force or voltages are applied that are outside specified ranges, or for the use of power supplies or amplifiers not sold by PI unless such use is expressly approved in writing by PI.

The following notes also apply:

1. Prices are FOB Auburn, MA
2. Payment terms are Net 30 and are subject to PI credit approval at time of shipment
3. Quoted delivery is valid at this time and is subject to change based on receipt prior orders. Actual delivery will be determined when the order is received.
4. Standard PI Terms & Conditions apply.
5. Purchase orders issued for items on this quotation acknowledge acceptance of all stated terms and conditions.

9-Oct-01

## PI (Physik Instrumente) L.P. 16 Albert Street, Auburn, MA 01501 ( Dated May 5/2005)

### Terms and Conditions

1. **GENERAL:** All Quotations, Products and Services provided by PI (Physik Instrumente) L.P. ("PI") are furnished only on the Terms and Conditions stated herein.  
All orders for PI's Products, if set forth on any forms apart from an unqualified acceptance of PI's Quotation form, are subject to written acceptance at PI's sales offices or its head office in Auburn, Massachusetts. PI reserves the right to reject any purchase orders. Any Quotations furnished by PI shall expire 30 days following the date set forth on the specific Quotation form, and may be revoked, amended or otherwise revised by PI by written notice prior to acceptance by PI.
2. **PRICES:** All prices published by PI are subject to change without notice. Unless otherwise indicated, quoted prices are applicable only to United States sales; international sales are governed by PI's current international published price lists. Prices are exclusive of all sales and/or excise tax unless otherwise specified in writing. PI does not report, pay or collect any tax which may be imposed on the Buyer unless such charge is separately stated on the face of the invoice for such Products. Prices for Products are quoted F.O.B. Auburn for PI manufactured products. Quoted prices do not include shipping, duty, sales taxes, license fees, inspection fees or any other fees required for operation of the equipment unless otherwise specified.
3. **CONDITIONS OF SALE:** The signed purchase order will be considered a binding purchase agreement between both parties. Buyers unqualified acceptance of the PI Quotation form shall constitute a signed purchase order. Acceptance by Buyer of these terms may be made either by written acceptance or by receipt by Buyer of delivery of any one or any part of the Products to be delivered.
4. **PAYMENT:** The price for each product is based on payment in accordance with one of the following payment alternatives, to be elected at time of order (if no written election is set forth, the first alternative shall be deemed elected):
  - a. Net 30 days from the date of invoice subject to approved credit at the time of order invoicing.
  - b. 85% net 30 days from the date of delivery, the balance on final acceptance.
  - c. Presentation at time of order of an irrevocable letter of credit from a credible U.S. domiciled bank, providing for payment on sight 30 days from the date of delivery. Past due balances shall be subject to a service charge of the lower of 1.5% per month or the legal maximum percentage. If Buyer fails to make prompt payment, PI may cancel or delay delivery of Products, or may repossess the Products without notice, and/or avail itself of any available remedy.
5. **DELIVERY AND SHIPMENT:** Delivery for Products will be by a common carrier of PI's selection unless otherwise noted in writing. Partial shipments are permissible. In the absence of specific shipping instructions, PI will ship by the method it deems most advantageous.
6. **PERFORMANCE:** Dates indicated for delivery or other performance represent PI's best estimate. PI shall not be liable for any loss, damages or penalties or in any other way because of any other delay in performance or failure to give notice of any delay due to unforeseen circumstances or to causes beyond its control. For delays resulting from any such causes, performance shall be correspondingly extended.
7. **SECURITY INTEREST:** PI hereby reserves a purchase money security interest in the Products delivered and the proceeds thereof, in the amount of the purchase price. These interests will be satisfied when the Products are paid for in full. Buyer authorizes PI to file in any applicable jurisdiction. Financing Statements executed only by PI, describing the Products sold herein as the collateral. On the request of PI, Buyer will execute Financing Statements and other instruments required to perfect PI's security interest and to pay the cost of filing or recording the same in all public offices, whenever PI deems filing or recording to be necessary or desirable. PI or its representatives may enter upon Buyer's premises at any reasonable time to inspect the Products until payment has been made in full.
9. **REMEDIES:** Upon any default by Buyer of any obligation under this agreement, PI may declare all such obligations immediately due and payable, and avail itself in addition to any other remedies or all of the remedies of a secured party under the Uniform Commercial Code or other applicable law.
10. **INSTALLATION AND ACCEPTANCE:** If installation and acceptance terms are required and specified in the accompanying PI Quotation related to the order, final coordination of the installation requirements shall be made by Buyer and PI no later than one (1) month prior to the scheduled date, unless otherwise agreed to in writing by PI. Buyer shall be responsible for having the building, equipment and service ready to receive the Products on the estimated delivery date. Buyer shall provide necessary labor and service to unload the Products from the transport vehicle. Installation shall be performed under the supervision of PI's installation engineer. Upon completion of the installation, PI's installation engineer shall demonstrate the Product. Each Product shall be deemed accepted by Buyer upon completion of the demonstrations showing that the Product performs according to published specifications, and Buyer agrees to execute PI's acceptance letter upon completion of such demonstration. Use of any Product by Buyer, its agents, employees or licensees, for any purpose after delivery thereof, without express written consent of PI, shall also constitute acceptance of the Product by Buyer.
11. **WARRANTY- HARDWARE:** PI warrants each Product manufactured by it to be free from defects in material and workmanship for one (1) year from the date of shipment, unless indicated differently. Parts replaced or repaired under this warranty are warranted only for the remaining portion of the original warranty period applicable to the Product in which they are installed. Any Products purchased from PI which become defective during the warranty period will be replaced or repaired by PI at the Buyer's site or at PI's site in Auburn, Massachusetts, or at a PI designated facility, at PI's option, that being the **EXCLUSIVE REMEDY** under this warranty. Buyer shall promptly notify PI of any claim, and PI shall have the option to inspect and test each item claimed to be defective at Buyer's site or request the Product to be shipped to PI's site or designated facility. Buyer shall bear all freight

#### PI (Physik Instrumente) L.P.

Head Office: 16 Albert Street, Auburn, MA 01501  
Tel: 508-832-3456 Fax: 508-832-0506 Email: info@pi-usa.us

West Coast: 5420 Trabuco Road, Ste. 100, Irvine, CA 92620  
Office Tel: 949-679-9191 Fax: 949-679-9292

charges within the United States for the return of any Products for warranty repair or replacement; return freight charges will be borne by PI. This warranty does not extend to any Products that PI determines were misused or neglected in use, storage or handling; or that were modified or serviced without PI's authorization or which have had their original identification markings removed, altered or defaced. PI MAKES NO OTHER WARRANTIES, EXPRESS OR IMPLIED, AND NO WARRANTY OF MERCHANTABILITY OR FITNESS FOR A PARTICULAR PURPOSE, EXCEPT AS EXPRESSLY SET FORTH IN THE ABOVE WARRANTY. IN NO EVENT WILL PI BE LIABLE FOR ANY INDIRECT OR CONSEQUENTIAL DAMAGE ARISING OUT OF OR IN CONNECTION WITH THE USE OR PERFORMANCE OF THE PRODUCT.

12. WARRANTY – SOFTWARE & FIRMWARE: Unless otherwise provided in a Seller or third party license, Seller warrants that standard software or firmware Products furnished hereunder, when used with Seller-specified hardware, will perform in accordance with published specifications prepared, approved, and issued by Seller for a period of one (1) year from the date of invoice from Seller or its appointed distributor, as the case may be. Seller makes no representation or warranty, express or implied, that the operation of the software or firmware Products will be uninterrupted or error free, or that the functions contained therein will meet or satisfy Buyer's intended use or requirements.

13. RETURNS: In no case may Products be returned without PI's written permission, which it may grant or deny in its sole discretion. Credit returns must be in like-new condition and within thirty (30) days of shipment. Returns when applicable are subject to a minimum 25% restocking charge and up to 100% for OEM and custom manufactured items. Generally, returns will be allowed, if at all, only due to a stocking or ordering error by Buyer.

14. PO Cancellation: Most of the products offered by PI are made to order and therefore PI will not accept a PO cancellation 10 days after the issuance of the PO.

15. OEM delivery schedule changes: PI reserves the rights to grant or deny any such request. A price penalty may apply depending on the financial load it creates to PI and will be handled on a case by case basis.

16. INDEMNIFICATION: If any product is manufactured and/or supplied according to Buyer's drawings and specifications, Buyer shall assume all responsibility for, and shall indemnify and hold PI harmless from any liability resulting from a charge or allegation that such Product infringes or contributes to the infringement of any Letters Patent.

17. LICENSED SOFTWARE & FIRMWARE: Use of Products comprised of software and firmware may be subject to Buyer's acceptance of additional terms and conditions set forth in separate Seller or third-party license agreements that will control to the extent necessary to resolve any conflict with the terms and conditions stated or otherwise referenced herein. In the absence of a separate Seller's license agreement, Buyer is granted a non-exclusive, non-transferable license to use provided Seller's software or firmware only in object code form and solely in conjunction with Seller-provided hardware Products, with no rights to sublicense, disclose, disassemble, decompile, reverse engineer, or otherwise modify the software or firmware.

18. MISCELLANEOUS: Buyer shall be responsible for obtaining all permits and for meeting all other requirements of any kind whatsoever relating to state and local codes, regulations and ordinances.

All contracts for sale of Products by PI shall be interpreted under and governed by law of the State of Massachusetts, United States of America without regard to conflicts of law principles. The Terms and Conditions as set forth herein shall constitute the entire Agreement between Buyer and PI with respect to the Products ordered. PI shall not be bound by any terms in the Buyer's order which are inconsistent with the terms herein set forth. These Terms and Conditions supersede any other agreement between PI and Buyer in connection with the Products and services hereof. They cannot be modified, supplemented or rescinded except by writing, duly signed by the authorized signatures of both parties. If any part of these Terms and Conditions stated herein are held void or unenforceable, such part will be treated as severable, leaving valid the remainder of the Terms and Conditions notwithstanding the part or parts found void or unenforceable. In case of any breach or default by Buyer, PI shall be entitled to all its costs to enforce any or all of these Terms and Conditions, including reasonable attorney's and experts' fees and expenses and all court costs.

### Head Office:

**PI (Physik Instrumente) L.P.**  
**16 Albert Street**  
**Auburn, MA 01501**  
**Telephone: (508) 832-3456**  
**Fax: (508) 832-0506**

### West Coast Office:

**5420 Trabuco Road**  
**Suite 100**  
**Irvine, CA 92620**  
**Telephone: (949) 679-9191**  
**Fax: (949) 679-9292**

Hello Nicolas:

We can supply the mirror to the specifications listed below, made from 4" thick Corning ULE or Schott Zerodur for \$42,000, uncoated. Protected silver coating is \$1600 additional. Protected gold is \$2400 additional. Delivery is 6 months from receipt of order. Terms are 50% down with order, balance net 30 after shipment.

Please let me know if you would like a formal quotation.

Best regards,

James

James Mulherin  
President/Lead Optician  
Optical Mechanics, Inc.  
[jcmulherin@opticalmechanics.com](mailto:jcmulherin@opticalmechanics.com)  
[www.opticalmechanics.com](http://www.opticalmechanics.com)  
Tel (319) 351-3960  
Fax (319) 351-3943

-----Original Message-----

From: Nicolas Gorceix [<mailto:nicolasg@bbso.njit.edu>]  
Sent: Friday, December 12, 2008 6:22 PM  
To: [jcmulherin@opticalmechanics.com](mailto:jcmulherin@opticalmechanics.com)  
Cc: Nicolas Gorceix  
Subject: BBSO -parabolic mirror

Dear Mr Mulherin,

I work at the Big Bear Solar observatory, in California where we are building a new solar telescope. One of the instrument that we plan to have is a spectrometer to observe from 1 to 5 microns.

In this spectrometer, there is a large on-axis parabolic mirror used as a collimator and for focusing. Its focal length is 2340 mm and diameter 680 mm.

I would need a rough estimate of the price of such component. We have not perform any tolerance analysis yet. I suppose for now that we can assume the following:

- material Zerodur or equivalent
- image quality 1/10 lambda
- 40-20 scratch/dig
- tolerance on focal length 1%
- clear aperture 90%
- coating: protected silver or gold or none.

Could you please send me a quote, let me know if you have questions/comments

thank you,

Best regards,  
Nicolas

Nicolas Gorceix  
Big Bear Solar Observatory <http://www.bbso.njit.edu/>  
40386 North Shore Lane  
Big Bear City, CA 92314-9672, U.S.A.  
tel: 909-866-5791 ext 33  
fax: 909-866-4240